

PRESENTED BY THE AUBURN CORD DUESENBERG FESTIVAL

AUBURN

OFFICIAL EVENT GUIDE FOR LABOR DAY WEEKEND 2023



TITLE SPONSOR:





SUPERCHARGING *our* **COMMUNITY.**

Steel Dynamics is revved up to sponsor another Auburn Cord Duesenberg Festival, an event-filled annual homage to the local automotive industry of yesteryear. It's always a pleasure to promote events in the communities where we live, work, and play. What's more, many of the talented people of northeast Indiana have been instrumental in our success.



**PROUD SPONSOR OF THE
AUBURN • CORD • DUESENBERG FESTIVAL**

www.steeldynamics.com

Extended Festival Hours

8 a.m. - 9 p.m.

Friday, September 1

Saturday, September 2



Preserving the Legacies of the Automotive World



Auburn Cord Duesenberg Automobile Museum

Located in the original 1930s international headquarters of the world-renowned Auburn Automobile Company, the Auburn Cord Duesenberg Automobile Museum displays over 120 classic, antique, and special interest vehicles.

Visiting the museum is like stepping back in time to the golden age of automobile design and innovation.

The museum is open to the public from 9 AM - 5 PM, seven days a week. Visit our website to learn more about group tours and educational programs.

1600 South Wayne Street, Auburn, IN 46706

260-925-1444

automobilemuseum.org



FOLLOW US ON TWITTER, FACEBOOK, INSTAGRAM, and TIK TOK!



Classic Cars INDIANA



Classic Cars INDIANA



Classic Cars INDIANA



Classic Cars INDIANA

HAMILTON - IN
**DUSTY'S ROD RUN
DOUBLE H FARMS**
June 3rd-4th

AUBURN - IN
**MEET IN THE
MIDDLE MICRO
CAR MEET**
June 2nd-4th



AUBURN - IN
**ACD SPRING
WARM-UP**
June 9th - 11th

AUBURN - IN
**BACK TO THE
BRICKS KICK-OFF**
June 10th

AUBURN - IN
**ACD FESTIVAL
3RD THURSDAY
CRUISE-IN**
June 15th

AUBURN - IN
**ACD JUNE CARS
& COFFEE**
June 17th

AUBURN - IN
**ACD FATHER'S DAY
CLASSIC CAR
CRUISE**
June 18th

SPENCERVILLE - IN
**4TH SATURDAY
CRUISE-IN**
June 24th

AUBURN - IN
**ANTIQU
AUTOMOBILE
CLUB OF AMERICA**
DEKALB HIGH SCHOOL
July 8th

AUBURN - IN
**SHIFTERS CAR
SHOW
OUTDOOR THEATRE**
July 8th

AUBURN - IN
**ACD JULY CARS
& COFFEE**
July 15th

AUBURN - IN
**NATIONAL MODEL
A TOUR NATMUS
/ FORD**
July 16th - 21st

AUBURN - IN
**ACD FESTIVAL 3RD
THURSDAY
CRUISE-IN**
July 20th

BUTLER - IN
**4TH SATURDAY
CRUISE-IN**
July 22nd

BUTLER - IN
**RADIO CONTROL
MONSTER TRUCK
NATIONALS**
August 11th - 13th

AUBURN - IN
**ACD FESTIVAL 3RD
THURSDAY
CRUISE-IN**
August 17th

AUBURN - IN
**ACD AUGUST
CARS & COFFEE**
August 19th

WATERLOO - IN
**OLD 27 CAR TOUR
WATERLOO**
August 22nd

ST. JOE - IN
**4TH SATURDAY
CRUISE-IN**
August 26th

DEKALB COUNTY
**ACD FESTIVAL
GARAGE CRUISE**
August 27th

**ALLIEN-COOL
FESTIVAL**
AUBURN - IN
**AUBURN CORD DUESENBERG
FESTIVAL**
August 29th - September 2nd

AUBURN - IN
**SWEETCARS
FAST & FABULOUS**
September 2nd

AUBURN - IN
**ACD SEPTEMBER
CARS & COFFEE**
September 16th

AUBURN - IN
**ACD FESTIVAL 3RD
THURSDAY
CRUISE-IN**
September 21st

BUTLER - IN
**4TH SATURDAY
CRUISE-IN**
September 23rd



**WORLDWIDE
AUBURN AUCTION**
AUGUST 31 - SEPTEMBER 2, 2023



BUTLER - IN
**MONSTER TRUCK
FALL EVENT**
September 23rd

Classic Cars INDIANA

VISITDEKALB.ORG

BUILDING ON TRUST



DESIGN/BUILD INTERIOR RENOVATIONS BUILD/LEASE MAINTENANCE

7701 Opportunity Drive
Fort Wayne, Indiana 46825



SHAWNEE
Construction & Engineering

(260) 489-1234
shawneeconstruction.com

WELCOME



MIKE BOSWELL
PRESIDENT

ACD Festival Board of Directors

On behalf of the ACD Festival Board of Directors, I would like to welcome you to Auburn! We are looking forward to renewing acquaintances with friends and fellow car lovers. We have put together a wonderful weekend of events and activities for everyone to enjoy. Our traditional events such as the Hoosier Tour, Kick-Off Luncheon, 9th Street Experience, Friday Night Cruise-In, Saturday parade and courthouse square viewing of the ACD Club cars all will happen again this year.

We also have newer events returning such as the Saturday night Fast and Fabulous cars, Ticket to Ride, four awesome bands performing on Friday and Saturday, and the 7th Street food alley. Several new events will make their debut this year as well. On Friday night there will be a Panel Jam Auto Art Show pinstripe painting event, and on Sunday afternoon we will have the Aero & Wing Car Invitational around the courthouse square.

We are most appreciative of our sponsors and advertisers listed in this publication who make it possible for us to bring these events to Auburn for everyone to enjoy. Without their gifts, putting on the ACD Festival would not be possible. Please take a moment to thank them for their generosity. Once again, welcome to Auburn. I hope your time with us is enjoyable. ■

ACD Festival 2023: Supercharged Cars and Supercharged Growth

This 67th Auburn Cord Duesenberg Festival will once again bring thousands of car enthusiasts to Auburn, Indiana, the "Home of the Classics." The festival's success and its continued growth continue to amaze me each year.

This year residents and visitors from around the world will pay homage to The Year of the Supercharged Car. This annual event highlights the city's rich automobile heritage while also highlighting the community's enduring spirit.

This enduring spirit of our community is resourceful, rejuvenating and, perhaps most importantly, revitalizing. Just as we celebrate The Year of

the Supercharged Car, we can also celebrate the supercharged growth we are seeing within our area.

Since many of you were last here, the city has grown with new restaurants and commercial developments, with several others on the way.

As in years past, there is something for everyone at the ACD Festival. Whether you have a love for the classics, modern muscle cars, exotics, street rods, historic muscle cars or trucks, they will all be in downtown Auburn throughout the week.

On behalf of the City of Auburn, we welcome you and hope your festival visit is a memorable one. ■

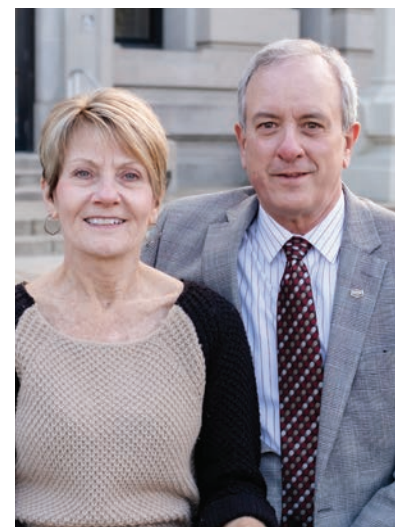

MIKE LEY
MAYOR



DRIVE INTO HISTORY TODAY!

The museum exists to collect, preserve and exhibit the history and heritage of the products manufactured by the Ford Motor Company. We house fantastic examples of 1932- 1953 Ford automobiles that introduce people to the flathead era.

2181 ROTUNDA DR.
AUBURN IN 46706
260-927-8022

WWW.FORDV8FOUNDATION.ORG
INFO@FORDV8FOUNDATION.ORG

OPEN DAILY 9AM -5PM

WELCOME



Welcome to the ACD Festival – the “Home of the Classics!”

Every year Auburn, Cord and Duesenberg owners and enthusiasts return home to the historic city of Auburn, Indiana where it all began.

This year we celebrate the festival’s theme, The Supercharged Car. What an exciting year to attend. Watch for the chrome side pipes on all the amazing ACD cars roaring around town. There will be plenty of them to enjoy, smell and hear!

Check out the Auburn Cord Duesenberg Automobile Museum on Thursday and Friday at 12:00 p.m., as many ACD cars will be lined up out front. In the evening, be sure to spend time downtown on 9th Street just off the square. Here you will find many ACD cars and their owners milling about, telling tall tales of yesteryear. It’s a very special time, so please stop by.

On Saturday, be sure to visit Eckhart Park in the morning to see these incredible automobiles up close while they are judged. At 1:00 p.m. they will leave the park and parade downtown to the square, so that all attendees can see them in motion and get an up-close look as they park for the afternoon.

It’s so great to have you all with us for this very special annual Auburn Cord Duesenberg homecoming event, which is truly like no other in the world.

Please engage with the car owners and ACD Club members, and enjoy everything Auburn during this very special time! ■

BOB BECKER
PRESIDENT
ACD Club

acdclub.org

2023 Garage Cruise

27TH August



VISIT AND TOUR
MULTIPLE GARAGES

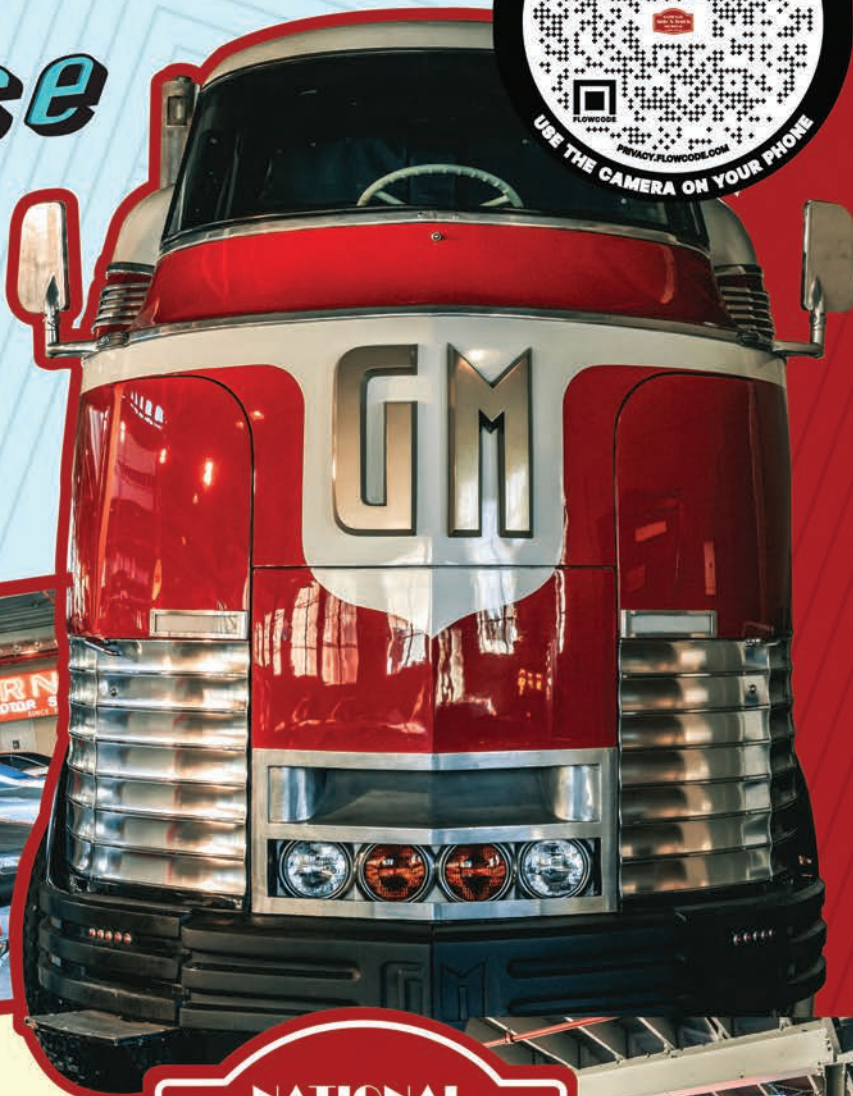

**NATIONAL
Auto & Truck
MUSEUM**
AUBURN, INDIANA



- ▶ **175 DIFFERENT VEHICLES**
 - ▶ CLASSICS
 - ▶ MUSCLE CARS
 - ▶ CONCEPT CARS
 - ▶ LIGHT AND HEAVY DUTY TRUCKS
 - ▶ INTERNATIONAL TRUCKS
- ▶ **OVER 7,500 DIE CAST MODELS**
- ▶ **ONE OF THE WORLD'S LARGEST COLLECTIONS**
 - ▶ TOKHEIM GAS PUMPS
 - ▶ VINTAGE PEDAL CAR DISPLAYS IN NORTH AMERICA
- ▶ **YOUTH EDUCATION PROGRAM**
- ▶ **VISIT THE NEWEST AUBURN DEALERSHIP TO OPEN IN OVER 85 YEARS**
- ▶ **LEGENDS OF NASCAR GALLERY**

TABLE OF

FEATURE



THE YEAR OF THE SUPERCHARGED CAR

PROFILE



BUILDING THROUGH TEAMWORK
STEEL DYNAMICS FLAT ROLL GROUP

PROFILE



DELIVERING ON A PROMISE
FAK LOGISTICS

FEATURE



BEHIND THE WHEEL

ADDITIONAL

40

FESTIVAL MAP

43

EVENTS CALENDAR

62

FRIENDS OF THE FESTIVAL

63

BUSINESS FRIENDS OF THE FESTIVAL

64

CHEERS TO THE FESTIVAL

66

FRIDAY DOWNTOWN ACD FESTIVAL CRUISE-IN

68

PARADE OF CLASSICS

CONTENTS

FEATURE



20

GRAND MARSHAL
CORKY COKER

FEATURE



22

THE GREAT RACE

PROFILE



34

EXTRAORDINARY CARS, EXTRAORDINARY SERVICE
SWEETCARS

FEATURE



36

4 QUESTIONS WITH RILEY SCHLICK-TRASK

70
TICKET TO RIDE

72
FAST AND FABULOUS

74
BASIC INFORMATION &
SPONSOR RECOGNITION

75
SHUTTLE MAP

76
ADVERTISER DIRECTORY

78
THANK YOU FROM THE
EXECUTIVE DIRECTOR

ADDITIONAL

BOARD OF DIRECTORS



PHOTOGRAPHY BY DAVID TURNER

BOARD MEMBERS

FIRST ROW
LEFT TO RIGHT

Travis Sprouse

Leslie Peel
EXECUTIVE DIRECTOR

Cecile Weir
TREASURER

SECOND ROW
LEFT TO RIGHT

Robert Probst

Mike Boswell
PRESIDENT

Amanda Peet
FESTIVAL ARTIST

THIRD ROW
LEFT TO RIGHT

Mike Payne
VICE PRESIDENT

Jack Bassett

Daisy Cook

Bill Hohler

BACK ROW
LEFT TO RIGHT

Tim Straley

Brandon Anderson

Josh Conrad
SECRETARY

NOT PICTURED

Troy Ackerman

Tim Butler

Damian Dunn

John Maloy

Thompson Smith

PUBLISHED BY
Michiana Business Publications, Inc.

COVER PHOTO BY
Jeffrey Crane

© 2023 ALL RIGHTS RESERVED
AUBURN CORD DUESENBERG FESTIVAL, INC.

P.O. Box 6019
1600 Wayne St. | Auburn, Indiana 46706
(260) 925-3600 | acdfestival.org



SUPERCHARGE YOUR HOME'S

Curb appeal

As a proud sponsor of this year's Auburn Cord Duesenberg Festival, Bushey's Windows and Doors would like to congratulate this year's organizers on another successful ACD event.

Bushey's has the experts to steer your home improvement journey in the right direction with a broad selection of fully customizable windows and doors that fit any budget or style.



JEFF & JIM BUSHEY

busheysfw.com



ARTICLE BY Sam Grate, Curator,
Auburn Cord Duesenberg Automobile Museum
PHOTOGRAPHY BY Jeffrey Crane & Provided

THE YEAR OF THE SUPERCHA



R G E D C A R



SPEED. POWER. EFFICIENCY.

Three words that describe Auburns, Cords and Duesenbergs, but when you see or drive one with a supercharged engine, they take on a whole new meaning. The Auburn Automobile Company and Duesenberg, Inc. led the way when it came to supercharging their automobiles. It was seen as a means to add speed, power and efficiency to automobiles without having to design a larger, heavier engine and automobile.

What is a supercharger and what does it do? In short, a supercharger is an air compressor that adds more air pressure into the cylinders of an engine through the means of a fast spinning impeller. The greater the air and fuel mixture that is compressed, the higher the output of power. It allows a more efficient combustion of the fuel mixture by evenly distributing the mixture throughout the engine. With Auburn, Cord and Duesenberg automobiles, the supercharger is mechanically driven and the impeller spins at speeds up to six-times the engine speed. If the engine is rotating at 2,000 rotations per minute (rpm), the impeller is spinning at 12,000 rpm!

Duesenberg, Inc. saw the advantages of superchargers and applied it to its own engines. It was the first to add them to its engines for use in racing. In 1932, after the introduction of the Model J in 1929, Duesenberg added a centrifugal supercharger to its engine as an option for an additional \$1,000. Already a powerful straight-eight-cylinder engine at 265 horsepower, it boosted the output to a whopping 320 horsepower, an increase in power of 20%. Duesenbergs that were fitted with the supercharger carried the designation "SJ." The exhaust manifold had to be designed differently to accommodate the supercharger unit. A few designs were made, but the most common was four exhaust pipes covered in attractive flex stainless steel that exited the passenger side of the engine compartment. Zero to 60 mph was achieved in about eight



Keeta

Reinventing the global banking system,
with speed, efficiency, and sustainability.

FAST CROSS-BORDER PAYMENTS

SECURE, SCALABLE, & COMPLIANT

A FULL SUITE OF APIs

Learn more at keeta.com

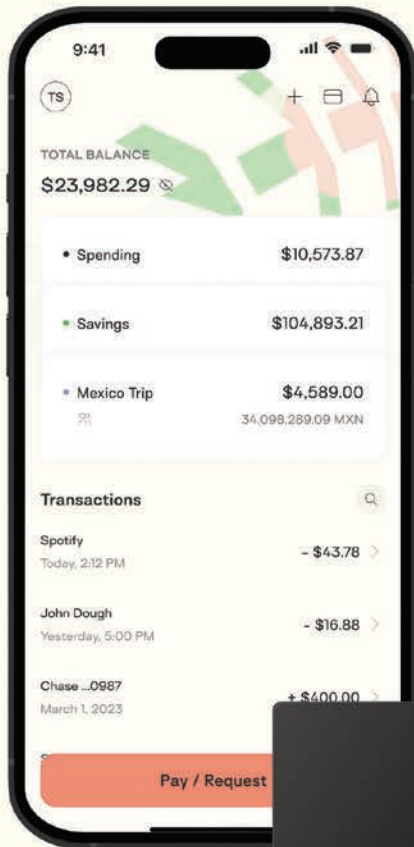

*Keeta Payments App
& Keeta card

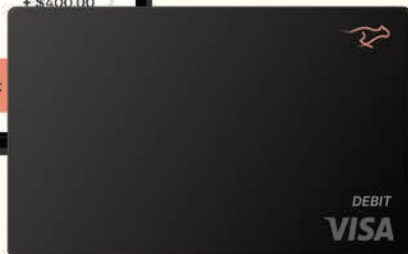

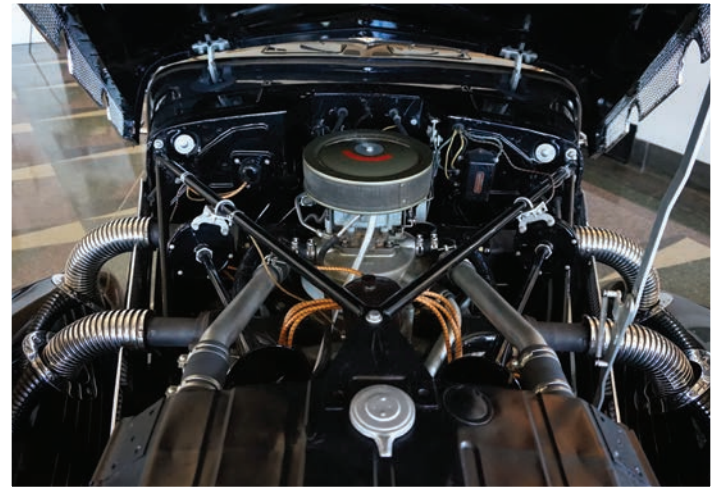
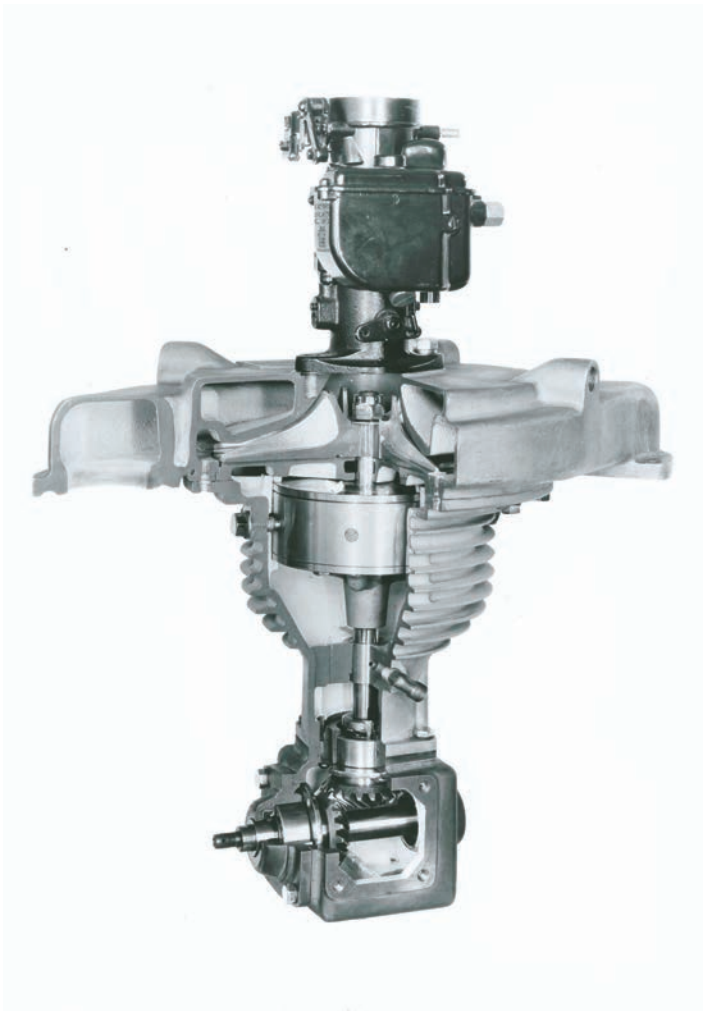

seconds, depending upon which body style was chosen. Only 36 Duesenbergs were supercharged by the factory.

Supercharged eight-cylinder engines were added to the line of Auburn automobiles as an option in 1935 and 1936. They were available for all body styles. Naturally aspirated, the 1935 and 1936 Auburn eight-cylinder Lycoming engines produced 115 horsepower. With the centrifugal Schwitzer-Cummins supercharger, the engine output was rated at 150, an increase in power of 30%. Zero to 60 mph was achieved in about 15 seconds. On average, a supercharged car cost an additional \$500-700, depending on the body style. Four flexible stainless steel exhaust pipes that exited the driver's side of the hood indicated a supercharged engine. Auburn pushed its supercharged line heavily in marketing and in stock car racing. One such Auburn speedster, driven by Ab Jenkins, set over 70 stock car speed records in 1935, sanctioned through the American Automobile Association (AAA). The Auburn White Caravan was a 150-stop countrywide promotional tour whose purpose was to push sales of the supercharged Auburns. In total, 774 Auburns were produced with a supercharged engine by the time production stopped in early 1936.

The Auburn Automobile Company offered the option of supercharged engines to the Cord automobile in 1937 for an additional \$415. They were available for all body styles and for the custom line. Its V-8 engine produced 125 horsepower, but power charts indicated that the engine equipped with a centrifugal Schwitzer-Cummins supercharger

produced up to 190 horsepower. However, the company rated the engine at 170 horsepower. Zero to 60 mph was achieved in 13 seconds. Two stainless steel exhaust pipes exiting on each side of the hood indicated a supercharged engine. Just like with the Auburn line, supercharged Cords were used in stock car racing, time trials and more. Two supercharged Cords competed in the Stevens Challenge, a 24-hour endurance race held at the Indianapolis Motor Speedway in 1937. Driven by Ab Jenkins, the Cord broke the record by covering 1,909 miles in 24 hours for an average of 79.5 mph – a record that stood until 1954. Despite the racing accolades, the end was near for the Cord and the Auburn Automobile Company, which closed in August of 1937. In total, of the 2,995 Cord 810 and 812s produced, just 688 supercharged Cords were built by the factory.

Overall, supercharging attributed to a small portion of the Auburn, Cord and Duesenberg history. At the time it was seen as a means to reinvigorate the brands with an infusion of power and technology in already advanced automobiles. However, it ended up as a last gasp by the two companies to entice new consumers and reverse the decline in sales. Today, supercharged Auburns, Cords and Duesenbergs represent the very best of the Auburn Automobile Company and Duesenberg, Inc. They are among the most coveted automobiles produced by the companies. People continue to be allured and inspired by the speed, power and efficiency of these fine automobiles. ■



IGNITING POSSIBILITIES

DRI  E

2 0 2 3

Founded in 1993, today Steel Dynamics is one of the largest and most diversified domestic steel producers and metals recyclers in the United States.

We are extremely proud of our accomplishments and look forward to celebrating our 30th anniversary during 2023. We are thankful to all who have contributed to the safety and performance of our growing company.

We differentiate ourselves through an **exceptional and unique operating culture**, a **diversified and value-added product portfolio**, a **low-cost operating base**, and an **entrepreneurial spirit** that permeates our entire organization. These factors drive us forward, and create long-term value for all those involved with our company—and we thank you.



Safety

Customer Commitment

Superior Operating Culture

Strategic Growth

Innovation

Financial Strength

steeldynamics.com

BUILDING THROUGH TEAMWORK

NEW STEEL DYNAMICS, INC. GENERAL MANAGER VALUES SDI'S TEAM MEMBERS.

ARTICLE BY Julia K. Porter, PhD | PHOTOGRAPHY Provided

Steel Dynamics, Inc. (SDI) is one of the largest domestic steel producers and metals recyclers in the United States. The Butler Division is home of the original Steel Dynamics' mill and the first of the company's successful operations. Through its strategic principles and dedication to an employee-lead organization, Steel Dynamics works hard to understand the needs of its employees to further support customers.

Recently, Chad Bickford was named General Manager of the Butler Division. Bickford has been with SDI since 2003 and comes to the Butler Division from Steel Dynamics' company New Millennium Building Systems (NMBS).

Bickford graduated from Ohio University with a Bachelor of Science in Civil Engineering in 2003, and joined SDI's fabrication platform of NMBS in Butler, Indiana as a sales engineer. He worked in multiple NMBS divisions holding various roles, including engineering manager for the Lake City, Florida division, sales manager and general manager in the Salem, Virginia division. In early 2021, Bickford joined SDI's steel platform and was named the

general manager of the Engineered Bar Products Division in Pittsboro, Indiana. In March of 2023, he became the general manager of the Butler Division for SDI's flat roll group.

It's apparent that Bickford is passionate about continuing to uphold the innovation and growth of an employee-centric company. As he notes, "Our employees drive the company."

"From the moment new hires walk through the facility and hear about our innovative technology, products and processes, it's evident the majority of these ideas originate from our front-line employees. We empower people with performance goals, align their interests with expectations for safety, quality and customer service, provide them with the right tools and resources, and watch them succeed," Bickford explains.

In order to ensure Steel Dynamics continues to create a people-focused culture, leaders make it a point to actively listen to their team members.

"Our employees are extraordinary at what they do; staying intentionally engaged on their needs and ideas is a priority of leadership," Bickford says.





As a new leader in this division of SDI, Bickford has been spending time introducing himself and getting to know employees. Additionally, Steel Dynamics values transparency and communication, and he looks forward to hosting on-site employee meetings to give team members a “big picture” update of the operation. He also wants to listen to their ideas on further improving all aspects of the business. This dynamic has allowed for not only more innovative collaboration between leadership and employees, but also helps support SDI’s customers.

“Our teams are intensely committed to supporting our customers,” Bickford notes. “Having over 1,000 SDI Butler team members executing every day to exceed our customer expectations

increases our value and supports future growth with our customers.”

What’s next for Steel Dynamics? In 2025, it will begin operating on a completely new platform in aluminum through a brand-new 650,000-metric-ton recycled aluminum flat roll product facility in Columbus, Mississippi.

SDI continues to look for new team members and is actively hiring. It continues to pave the way in meeting employee needs, offering exciting opportunities and providing resources for professional growth. Applicants need to be committed to safety and ready to learn.

“There are awesome opportunities within this company,” explains Bickford. “If they have a true passion for safety and commit to going home safely every day, we are happy to share the knowledge and provide tools for the technical and operational responsibilities of their role.”

Individuals who are interested in exploring career opportunities at Steel Dynamics, Inc. should go to steeldynamics.com and visit the Careers section. ■

STEEL DYNAMICS FLAT ROLL GROUP - BUTLER DIVISION

4500 COUNTY ROAD 59
BUTLER, INDIANA 46721
(260) 868-8000

STEELDYNAMICS.COM/BUTLER
NUMBER OF EMPLOYEES: 1,041
YEARS IN BUSINESS: 27 (1ST COIL
PRODUCED IN DECEMBER, 1995)
PRODUCTS AND SERVICES:
MANUFACTURER OF FLAT
ROLL STEEL COILS

CORKY COKER



Joseph "Corky" Coker says it's almost as if he was born to be a part of the collector car hobby and the specialty equipment market. Corky's father Harold started Coker Tire in 1958 and named his son after the Sunday newspaper comic strip "Gasoline Alley" – Corky thinks he was destined to be into all things gasoline, cars and restoration. Despite being raised around the family tire business and collector cars, Corky grew up raising livestock on the family's farm. He originally thought he wanted to become a veterinarian, but quickly realized he wasn't quite the student it took to be successful in veterinary school.

Corky's dad asked him to come back home to take over the vintage tire portion of the family's tire business. He soon discovered that he really loved the people and the cars in the collector car world. "I began to realize that the people buying vintage and hot rod tires were really happy spending money with us because I helped them get to play with their toys," he says. "I soon got my head (and my whole heart) into it and started developing ideas and goals of my own." Over the years, Corky put those ideas into practice and began adding

product lines and other businesses. He acquired vintage tire molds from all over the world, contracting with quality tire manufacturers to produce the company's product line. He chased old original tire molds and negotiated licensing agreements with companies like BFGoodrich, Firestone, Michelin and U.S. Royal Tires, and he developed many new brands also owned by Coker Tire. Coker Tire grew to be the largest supplier of vintage and collector vehicle tires in the world, averaging shipping two tractor trailers full of tires per day to individuals all over the country and to its distributors in 50 countries outside the U.S.

Corky's personal auto collection includes more than 150 collector cars and 100 antique motorcycles, and he takes part annually in The Great Race – a timed speed distance endurance car event that runs from coast to coast. In 1998, Coker acquired Honest Charley, America's first mail-order speed shop founded in 1948 by Honest Charley Card himself. Honest Charley celebrates its 75th anniversary this year in 2023.

As he worked to grow his businesses, Corky also devoted much of his time building the whole industry through his

efforts with SEMA (Specialty Equipment Market Association). He was one of the founders of the Automotive Restoration Market Organization, which named Coker Tire its Manufacturer of the Year in 1997 and inducted Corky into the ARMO Hall of Fame the following year. He served numerous terms on the SEMA board of directors and became the association's chairman in 2003. Corky was inducted into the SEMA Hall of Fame in 2008.

Though faith and charity are hallmarks of his character, Corky's humanitarian and community involvements are less well-known. He is a recipient of the Silver Beaver Award from the Boy Scouts of America and has been very active promoting Chattanooga, Tennessee for years. He was selected as Chattanooga's Businessman of the Year in 1995 and as Tennessee's Business-Person of the Year by the Small Business Administration in 1996. He recently joined the board of Bible In The Schools in Chattanooga. He has made numerous short-term mission trips to places like the Caribbean Christian Center for the Deaf in Jamaica and the Chosen Children Ministries, a Christ-centered ministry for orphanages with a focus in Nicaragua.

"I learned that it's always the right thing to do the right thing," he says. "I became a Christian in my early 20s, but have learned that I need to be in God's word daily because His word is real truth."

Faith and family are extremely important in Corky's life, both personally and in business. As major influences guiding him, he points to his mother Lill Coker, his father Harold Coker and his grandfather Pop Coker, but most importantly daily time in God's word. He has been married to his wife, Theresa Mondl Coker for 45 years. His two children, Casey and Cameron, both worked in the Coker family businesses. ■

Source: http://www.semahof.com/Corky_Coker_2008_Inductee

1971
PETER DE PAOLO

1972
GORDON BUEHRIG

1973
HOWARD "DUTCH"
DARRIN

1974
CHRIS SCHENKEL

1975
TONY HULMAN

1976
HAROLD AMES

1977
GORDON BUEHRIG

1978
ALICE HUYLER RAMSEY

1979
HAROLD AMES

1980
ALEX TREMULIS

1981
DAN HAGGARTY

1982
GORDON JOHNCOCK

1983
ROBERT ORR

1984
VIRGINIA CORD

1985
JOHN MUTZ

1986
THOMAS MONAGHAN

1987
DENNY DUESENBERG

1988
RICHARD KUGHN

1989
CHRIS SCHENKEL

1990
KAY BUEHRIG

1991
CARROLL SHELBY

1992
ANDY GRANATELLI

1993
DEAN KRUSE

1994
RODGER WARD

1995
FRANK BORMAN

1996
DAVE THOMAS

1997
JERRY J. MOORE

1998
DALE ROBERTSON

1999
JOHN MARTIN SMITH

2000
KEITH CRAIN

2001
S. TRUETT CATHY

2002
DENNIS GAGE

2003
DEL MAR JOHNSON

2004
SALLY HUMMEL,
NANCY PHELPS AND
SUSAN PEREIRA

2005
GLENN PRAY

2006
DEL MAR JOHNSON

2007
DORIS JOHNSON

2008
CLINT STEPHENS

2009
CLIVE CUSSLER

2010
PAUL & MARTHA BRYANT

2011
THE GORDON
BUEHRIG FAMILY

2012
BOBBY UNSER

2013
WAYNE CARINI

2014
COURTNEY HANSEN

2015
THREE RANGERS
FOUNDATION

2016
JOHN SOUDER

2017
JAMES OTTO

2018
ADDISON AGEN

2019
DENNIS COVERT

2021
LYN ST. JAMES

2022
RICK DORE ■

FOR ALL YOUR UNIQUE BANKING NEEDS, F&M HAS YOU COVERED.

Since 1897.

Auburn Office
406 Smaltz Way
Auburn, IN 46706

Member FDIC
NMLS# 407535

F&M BANK

THE Official BOTTLER
OF THE ACD FESTIVAL WINE

COUNTRY HERITAGE WINERY AND VINEYARD

0185 CR 68 | LaOtto, IN 46763
WINERY HOURS | 11-10 Friday & Saturday
11-8 on Sunday-Thursday

CH
COUNTRY HERITAGE WINERY



GRETT



R



THE AT ACE

TWO YOUTH TEAMS ARE REPRESENTING AUBURN, INDIANA IN THE GREAT RACE 2023 – A TEST OF DRIVER NAVIGATION AND DISCIPLINE ON A CROSS-COUNTRY TRIP.

ARTICLE BY Gavin Swift, NATMUS X-Cup Team Member
PHOTOGRAPHY Provided



2023

GREAT RACE ROUTE

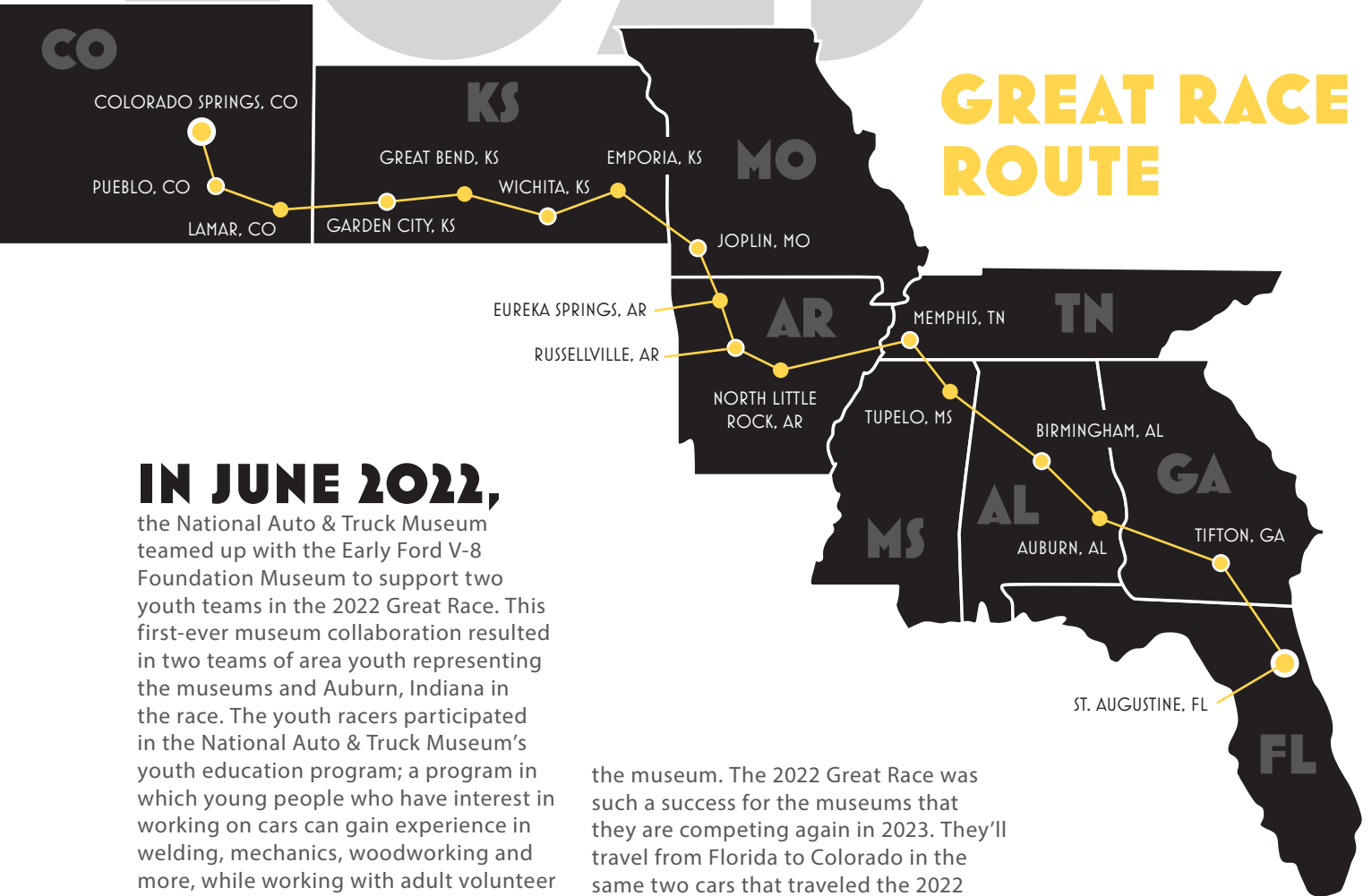

IN JUNE 2022,

the National Auto & Truck Museum teamed up with the Early Ford V-8 Foundation Museum to support two youth teams in the 2022 Great Race. This first-ever museum collaboration resulted in two teams of area youth representing the museums and Auburn, Indiana in the race. The youth racers participated in the National Auto & Truck Museum's youth education program; a program in which young people who have interest in working on cars can gain experience in welding, mechanics, woodworking and more, while working with adult volunteer counterparts. In fact, the Early Ford V-8 Foundation Museum intends to start a similar youth education program in its new education workshop that neighbors

the museum. The 2022 Great Race was such a success for the museums that they are competing again in 2023. They'll travel from Florida to Colorado in the same two cars that traveled the 2022 race: A 1941 Ford Sedan and a 1948 Ford Coupe, both of which are powered by Flathead Ford V-8s. The cars were built to race readiness by the youth themselves.

25
YEARS

OAK
PARTNERS INC.
WEALTH & RETIREMENT PLANNING



ANDY SMITH,
MBA, AAMS®
WEALTH ADVISOR

MARK VANDEVELDE,
CFP®, AIF®
WEALTH ADVISOR

TINA BLOMEKE
OFFICE MANAGER

PAYTON RHODES YARIAN
DIRECTOR OF
BUSINESS DEVELOPMENT

NICK SCHEUMANN
WEALTH ADVISOR

HERE AT OAK PARTNERS, OUR ADVISORS STRIVE TO:



INVEST
FOR GROWTH AND INFLATION DEFENSE



BUILD A
PORTFOLIO
THAT SUPPORTS YOUR LIFESTYLE



PRESERVE
YOUR NEST EGG

SECURITIES AND ADVISORY SERVICES OFFERED THROUGH LPL FINANCIAL, A REGISTERED INVESTMENT ADVISOR, MEMBER FINRA/SIPC.

1710 N. MAIN ST., SUITE B | AUBURN, INDIANA 46706 | (260) 927-0226 | OAKAUBURN.COM

The Great Race is a nine-day time rally race for vintage vehicles. Unlike a typical race, it involves following highly specific instructions that usually take racers down back roads. The goal of the Great Race is not to finish first, but rather to follow instructions precisely enough so that the participants cross each checkpoint at the exact time determined by the Great Race staff. It's not as easy as it sounds. Race teams have to factor in the time lost by stopping, turning, etc. They must try to figure out that amount of time and then make it up during the drive. Furthermore, the teams do not know where the checkpoints are ahead of time, nor do they know what their time should be when crossing it. Each day, the race takes teams to



a lunch stop and a dinner stop. Both stops are set up similarly to Auburn's Third Thursday Cruise-Ins. The race cars are parked cruise-in style while

the racers eat lunch or dinner. During this time, the public can look at the race cars and interact with the racers. The Auburn youth teams are able

Your Community Network

Auburn Essential Services was founded on the timeless legacy of reliable performance and responsive customer service.

Come home to Internet, WiFi, and Phone from Your Community Network.

AUBURN ESSENTIAL SERVICES

260.333.0100
auburnessentialservices.net



Race staff that the Great Race's regional spring rally, a smaller version of the June event, was held in Auburn this past May. Additionally, a few of the original Auburn youth racers are taking charge of the Great Race youth program at the museums for years to come. The hope is to have the Great Race be an annual event that is offered as a reward for the museum's youth volunteers. While the future for the program does look promising, there are always challenges to address. The program is continuously fundraising and looking for donations as well

to speak with interested spectators while telling them about Auburn, DeKalb County and the museums.

The Great Race has become a part of both the museums' and Auburn's identity. The Auburn teams have made such a strong impression on the Great

as more youth volunteers who would be interested in participating. For more information on the program, visit natmus.org, fordv8foundation.org or museumcrew.com. ■

Gays

BEER WINE SPIRITS



The Tri-State's Liquor Stores!
 Helping Everyone Celebrate Every Day!

Hops-N-Schnapps



THINK WHEN YOU DRINK!

SERVICE ◦ SELECTION ◦ SAVINGS

WEEKLY & MONTHLY SPECIALS!



www.gayshopsandschnapps.com

OPEN EVERY DAY!
 611 WEST 7TH AUBURN

DELIVERING ON A PROMISE

ALEX HAGGARD, OWNER AND PRESIDENT OF INDUSTRY-LEADING FREIGHT BROKER FAK LOGISTICS, KEEPS FAITH WITH CLIENTS AND FAMILY.

ARTICLE BY Janet Patterson | PHOTOGRAPHY Provided



Alex Haggard admits that when he shifted career gears, he had no idea what the next week might hold.

The son of a single mother who worked long hours just to feed her three children, Haggard grew up with the firm conviction that success meant making lots of money. “Eventually, I did,” he says.

The North Side High School graduate worked for a decade in finance for various automotive groups. The long hours weren’t too bad, until he married and had four daughters. Eventually, the big house and new cars started to pale compared to the time he was missing with his family. It was then Haggard realized, “I was no longer enjoying my success.”

He left his job and started from the ground up on a new career path. “A friend of mine became an agent for Echo Global Logistics and was working out of the back of a U-Haul building in Westfield, Indiana. He invited me, along with another friend, to join the venture and we started MAD Logistics,” Haggard says. The three friends set about learning the ins and outs of the logistics business. “For months, we drove around behind businesses counting the

dock doors, figuring out their shipping needs and selling our services.”

Haggard was so committed to his new career that he and his wife, Allison, sold their 6,000 square foot home and their luxury cars. Along with their daughters, four dogs and whatever furniture would fit, they moved into an “itty-bitty house and drove two beater cars.”

Eventually, Haggard decided to branch out on his own and FAK Logistics was born in 2012. His professional experience and relationships in northeast Indiana helped to scale the business.

Today, FAK Logistics has reached \$60 million a year in revenue and has 20 employees running its day-to-day operations.

Haggard’s experiences have taught him valuable business lessons.

“I don’t currently own any trucks, but I did at one point,” he says. “It taught me how brokers should do business with carriers and how important that relationship is.”

His company oversees the entire process from booking the shipment to delivery, tracking it all with state-of-the-art applications. “We never give

freight back to a customer,” Haggard adds. “We always deliver on our promise, no matter the cost to us.”

The businesses’ success has given him the means to help nonprofits and other start-up businesses in the area. He is a partner of two restaurants and bars, two tree companies, two car lots and a real estate investment company. “I love to invest in people and their ideas,” he says.

Haggard credits his wife for sticking with him since day one. The days of the “itty-bitty house” are over for the family. They now live in a historic Forest Park Boulevard dream home that Haggard always told his high school friends he would someday own. He also has time to spend with his family and work on his growing classic car collection. ■

FAK LOGISTICS

201 W. MAIN ST.
 FORT WAYNE, INDIANA 46802
 (260) 449-9043 | FAKSHIPPING.COM
 OWNER/PRESIDENT: ALEX HAGGARD
 NUMBER OF EMPLOYEES: 20
 PRODUCTS AND SERVICES: FAK LOGISTICS, A MINORITY-OWNED BUSINESS SPECIALIZES IN “FREIGHT OF ALL KINDS.” WITH 50,000 CARRIERS IN ITS OVER-THE-ROAD (OTR) NETWORK, FAK LOGISTICS CAN SHIP, TRACK, AND DELIVER ANYWHERE FROM ONE TRUCKLOAD TO 5,000 TRUCKLOADS A MONTH FOR ITS CLIENTS

CRUISE TO THE MONUMENT

HISTORIC DOWNTOWN ANGOLA, INDIANA

U.S. 20 (Medal of Honor Highway) and Old U.S. Hwy 27

**CLASSIC CARS | HOT RODS | SPORTS CARS
MOTORCYCLES | AND MORE**



WEDNESDAY, SEPTEMBER 20, 2023

5:00PM - 8:00PM

Parking starts at 4:00pm | Register after Parking | NO FEE



City of Angola | 210 N. Public Sq. | Angola, IN 46703 | 260-665-7465 | mbird@angolain.org



BEHIND

THE

WHEEL

SUPERCHARGED CAR OWNERS MIKE HUFFMAN, BRAD WAKEN AND PAT LEAHY SHARE A PASSION FOR AUTOMOBILES AND THE CAR-ENTHUSIAST COMMUNITY THAT HAS CREATED LIFELONG FRIENDSHIPS. THEY SHARE WITH US HOW THEIR INTEREST IN CARS BEGAN, A BIT ABOUT THEIR SUPERCHARGED CARS AND WHAT THEY ENJOY MOST ABOUT THE ACD CLUB AND ACD FESTIVAL.

PHOTOGRAPHY **PROVIDED**

1

MIKE HUFFMAN

WHEN AND HOW DID YOUR INTEREST IN CARS BEGIN?

My mom tells me about family Christmas parties we attended when I was young. My aunt played the piano for everyone and I would always ask why she kept pushing on the brake, which was of course the pedal.

I've liked cars for as long as I can remember. I would build models as a young boy and had a slot-car race track, and I've always liked to take things apart and am mechanically inclined. I got my first car at 19-years-old and it was a used corvette. I enjoy all kinds of cars now, not just classics.

HOW DID YOU DISCOVER THE SUPERCHARGED CAR? WHAT ABOUT THIS CAR IS MOST SPECIAL TO YOU?

This particular car was used in the TV show "Boston Blackie" in 1951. At the time, it was owned by Asa Clark, the film editor of the show. It was then bought by Millard Wilkerson of California in 1952, who sold it to Don Real of Ohio in 1953. Real sold it to Vern Cunningham of Ontario in 1957 and in 2002 I purchased it from Cunningham. I was able to buy the car with the help of my good friend Randy Emma from California. So far, my wife and I have put 65,000 pleasurable miles on it. Of all the cars I own, the Speedster garners the most attention. People from all walks of life comment on it – from little children to grandmothers. They all recognize the beautiful lines of the Auburn Speedsters. When people ask what it is, few have heard of an Auburn. The Speedster has opened many doors for us over the years. There was a time when we were at



Mike Huffman's 1935 Auburn 851 Speedster



a gas station and needed to use the restroom, but were told they didn't have a public bathroom. The employee then asked if that was my black car at the pump. When I said "yes," she told me I could use the employee bathroom. That was the first time the Speedster opened a bathroom door for me!

We have driven the car on several ACD Club Tours, including many Hoosier Tours by the ACD Festival. We've even taken it on a 9,600 mile, seven-week trip from Hudsonville, Michigan to Florida, to California and then back to Hudsonville. I hope my wife and I can put many more wonderful miles on Boston Blackie.

WHAT DO YOU MOST LOOK FORWARD TO ABOUT THE ACD FESTIVAL? The annual ACD Festival Hoosier Tour. The tour arrives on the Thursday before Labor Day weekend, but we leave on Monday along with about 50 other cars. We stay in a hotel a couple nights and really enjoy each others company. We love cars and have been members of the ACD Club for over 25 years. We initially joined for the cars, but now it's for the cars and our friends we've made along the way – they're our people. We talk about cars together, but it's more than that. Everyone is so kind.

2

BRAD WAKEN

WHEN AND HOW DID YOUR INTEREST IN CARS BEGIN? I grew up as an automobile enthusiast with four generations of my family belonging to the ACD Club. I began working on cars and attending shows at a young age and continue to promote our automotive history by researching, maintaining and displaying the different cars. While we have other

makes of automobiles, the 1937 Supercharged Cord Cabriolet along with the ACD Club are what we are most involved with.

HOW DID YOU DISCOVER THE SUPERCHARGED CAR? WHAT ABOUT THIS CAR IS MOST SPECIAL TO YOU?

Our Cord Cabriolet was purchased new in New Mexico, and in the 1940s the original owner sold the car to a mechanic in northwest Oklahoma. In 1964, my uncle George Waken purchased the car and we began our first restoration. The car was painted bronze with a tan top and leopard-skin interior! While our first renovation was to make the car operational, our ultimate goal was a complete restoration. Throughout the early 1970s, we completely disassembled the car and restored it to its original condition. In 1975, our Cord appeared at its first

Auburn Labor Day event without the front sheet metal or front fenders. The full display of a working Supercharged Lycoming V-8 engine, front-wheel drive and shifting system was a hit. The Cabriolet won the Tom Mix Award for Best Cord at the ACD West Coast Meet in 1976 and 1977, and the Gordon Buehrig Award for Best Cord at the 1980 Auburn Reunion. Since then, the car has attended over 40 Auburn Reunions and has been driven from Oklahoma to Auburn 30 times – all as we continue to maintain the car in its original show condition.

WHAT DO YOU MOST LOOK FORWARD TO ABOUT THE ACD FESTIVAL? Uncle George started attending the Auburn



Brad Waken's 1937 Supercharged Cord Cabriolet

show in the 1960s and over the next 60 years we grew to four generations attending the event. Through time we have learned from the people that originally bought and maintained the cars, watched our ACD family grow and have seen the ACDA Museum turn into one of the premier automotive museums in the nation. The Auburn Reunion is a family event, not just for the Waken family, but for all our ACD family. The cars are a special bond for all of us, but the people are the reason that we keep coming back each year.

FCI
CONSTRUCTION
Your Vision, Our Experience - Together

- | | |
|-------------------------|---------------------|
| CONSTRUCTION MANAGEMENT | CARPENTRY |
| DESIGN BUILD | CONCRETE |
| PRE-CONSTRUCTION | MASONRY |
| GENERAL CONTRACTING | FACILITY COMPLIANCE |

WWW.FCI.CONSTRUCTION
260.927.8516

Serving Auburn for 15 years!

— great food & service —

Pastas | Pizzas | Calzones

Wood Fired Grilled Steaks & Seafood

Full Bar | Extensive Wine List

THE Italian GRILLE



Tuesday - Thursday
11 AM - 9 PM

Saturday 4 PM - 10 PM

Sunday 11 AM - 9 PM

Friday 11 AM - 10 PM

227 N. Duesenberg Drive Auburn, IN 46706
theitaliangrille.com

3

PAT LEAHY

WHEN AND HOW DID YOUR INTEREST IN CARS BEGIN?

When I was young, I was always fascinated with mechanical things. My father let me buy a 1959 Buick station wagon before I was able to drive. I started taking it apart and, soon after, my dad said it would never get put back together. It was hauled to the recycler. In our neighborhood there was a family that was into high-

performance cars. They had a couple of 1950s Corvettes and a 1964 AC Cobra. I was able to ride in them a couple times and then became their young apprentice. My first job was to sand down a 1956 Corvette and paint it with spray cans.

HOW DID YOU DISCOVER THE SUPERCHARGED CAR? WHAT ABOUT THIS CAR IS MOST SPECIAL TO YOU?

We've attended the ACD Festival for many years. My sister-in-law lived on Main Street and always hosted a family with a 1932 Auburn V-12. We enjoyed riding in it and vowed we would someday have an ACD car.

In 1999, my wife Kathy and I started our search. I had decided upon an 810-812 Cord sedan. After checking out a project car in Marion, I talked to a number of ACD members who were gathered at the museum parking lot on Labor Day and asked if anyone would be willing

to travel to Marion to check out my possible purchase. A club member named Ray Cloud who owned a 1932 Auburn Speedster mentioned he had a Cord he might sell. After an hour of grilling me on my intentions for the Cord, he decided I was fit for the job. It was a supercharged custom Beverly. When I asked why this would be a better choice than the Marion car, I was told a supercharged long wheelbase was better. We made a deal right then and there.

I have enjoyed participating in 20 Hoosier Tours with my sons and grandchildren in this car. I also enjoy displaying it on 9th Street and encouraging people to sit in it for photos – especially the younger kids.

WHAT DO YOU MOST LOOK FORWARD TO ABOUT THE ACD FESTIVAL? I look forward to the full week of activities, especially because it brings our family and friends together. Relatives and friends come from as far as Florida and California to enjoy the cars and festivities. Being an ACD Club member, I have enjoyed the lasting friendship of fellow members. I've also had the satisfaction of serving on its board of directors for nine years, and have influenced others to embrace the old car hobby. ■



INDIANA'S MOST TRUSTED ADDICTION TREATMENT FACILITY



MEDICAL DETOX INPATIENT SUBSTANCE USE TREATMENT MENTAL HEALTH TREATMENT



ALLENDALE TREATMENT



(833) 338-6946

www.AllendaleTreatment.com

EXTRAORDINARY CARS, EXTRAORDINARY SERVICE

SWEETCARS' TEAM OF AUTO ENTHUSIASTS DELIVER METICULOUSLY MAINTAINED VEHICLES AND PREMIUM CUSTOMER SERVICE.

ARTICLE BY Heather Herron | PHOTOGRAPHY Provided

Visit the SweetCars showroom and you'll see an Aston Martin DB11, a McLaren 720S, a Mazda Miata and everything in between.

"People are surprised to hear that we don't only house Ferraris and Lamborghinis. That's actually a very small portion of what we do. A lot of people ask, 'What is a 'SweetCar?' I literally search the country when I look for inventory and hand-pick the right vehicles," explains General Manager Michael Barney.

Founded and run by a group of lifelong car enthusiasts, SweetCars has become known for its wide selection of vehicles, attention to detail and white-glove customer service. Barney joined the team when the dealership opened in 2011, first working as a porter. "I was washing cars, taking out the trash and running errands," he recalls. He later worked as a detailer, moved into the sales department and was then promoted to operations manager – he was eventually named general manager. Barney takes immense pride in serving customers in northeast Indiana and across the country.

"Over the years, we've sold cars to people in 49 out of 50 states. We're still waiting on Hawaii," he says with a smile. "As for those who are buying from out-of-state, it's up to us to earn their trust. We have pretty thorough processes for helping facilitate out-of-state purchases. We can assist with shipping, financing, documentation and signing. There are some customers who come to us who have never bought a car sight unseen; they aren't familiar with how this works. Luckily, we've done it enough times that we can ease their concerns."

SweetCars offers standard detailing services as well paint corrections, ceramic coating and paint protection film. It can service and perform routine maintenance on all makes and models, no matter where the vehicle was purchased.

"We make sure to provide very concierge-level service. Our team interacts with our customers as if they're their own personal mechanic. It's an honest approach, which is what differentiates us."



For those who want to avoid the hassle of selling a car, SweetCars also takes consignments.

"Consignment is something we've done a lot more in recent years. At any given point, around 10% of our inventory is consigned. This means the customer still owns it while it's with us, but it basically gets treated just as one of our own vehicles would. Consignment is a good option if someone isn't in a hurry to sell and they want to try to maximize what they can get."

Located just outside of downtown Fort Wayne, the locally-owned company is known for treating customers like family, its fair prices and unmatched service. "I don't take a customer's trust lightly," stresses Barney. "The used car industry as a whole can have a negative reputation, so we do our best to combat that with every interaction." ■

SWEETCARS

2404 W. JEFFERSON BLVD.
FORT WAYNE, INDIANA 46802
(260) 207-2277 | SWEETCARS.COM
MICHAEL.BARNEY@SWEETCARS.COM
NUMBER OF EMPLOYEES: 22
PRODUCTS AND SERVICES:
AUTOMOBILE SALES, SERVICE
AND DETAILING



NONFERROUS METAL RECYCLING



SCRAP PROCESSING

State-of-the-art processing and lab-verified analysis result in the highest quality products in the market.

CONSULTING & MANAGEMENT

We combine expert consultation with creative, custom solutions to keep your scrap metal process as efficient and profitable as possible.

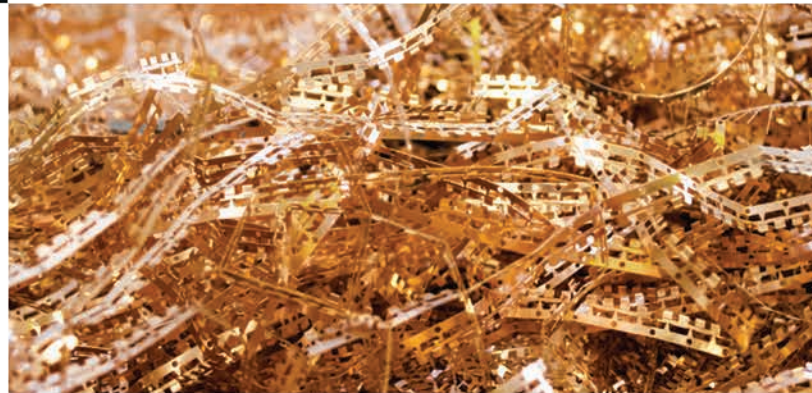

MELTING

Specification RSI and Ingot produced from aluminum scrap.

RETAIL & PUBLIC RECYCLING

We make the process fast, easy, and convenient for individual recyclers.



9910 DUPONT CIRCLE DRIVE E
FORT WAYNE, INDIANA

2222 W. COLISEUM BLVD
FORT WAYNE, INDIANA

1101 OREN DRIVE
AUBURN, INDIANA

50 DIMENSION AVE
WABASH, INDIANA

A MIND FOR METAL. (260) 232-3000 METALX.NET



Riley's  Rebuilds

4 Qs WITH *Riley Schlick-Trask*

OWNER, RILEY'S REBUILDS

ARTICLE BY Leslie Peel, ACD Festival Executive Director
PHOTOGRAPHY Provided

How does a 17-year-old, six-foot tall, soccer-playing entrepreneur get started rebuilding carburetors with her best friends? That's what intrigued me as I read Riley Schlick-Trask's story in a recent issue of *Hagerty Driver Club* magazine. The owner of Riley's Rebuilds has an interesting and inspiring story to tell. She recalls her recent appearance on the "All-Girls Garage" TV show on MotorTrend network as one of her top bucket-list experiences so far, describing it as, "A total dream come true to be with the hosts, Bogi and Faye, and show them how to setup and tune a carb." Schlick-Trask is active on social media with a strong and growing Facebook following, and even has her own YouTube channel stocked full of instructional videos for the auto-repair challenged.

Tell us a little about yourself and how you got into rebuilds.

I am a 17-year-old high school senior getting ready for college. I play competitive soccer as a goalkeeper and will soon be playing for Connecticut College – go Camels! I surf, skate and work on old cars. When I was 13, I wanted to buy my first car so I could work on it with my dad. I thought he would buy it for me. I started asking him about it and he made me a deal: He would match any money I made and we would put it toward my first car. I asked

him what I could do to make money. He had a lot of old car parts in the garage from past projects, so he let me clean them up, polish the chrome parts and sell them on eBay. I eventually found a carburetor and asked how much I would make if it sold. He estimated around \$200-300 and I said, "Let's do it!"

My dad taught me to rebuild the carburetors he had on hand and they sold fast. I then started searching on Facebook Marketplace and Craigslist to purchase others. We would drive around Florida on the weekends and buy them all. I was playing travel soccer at the time, so we drove A LOT. During the week after school, practice and homework, I would rebuild them. In about eight months I made enough money to buy my first car – a really ugly light blue 1995 YJ Jeep. I knew it was going to be a work in progress, so I kept rebuilding carbs to pay for parts and paint. Now it's a screen-accurate Jurassic Park Jeep with a sound board that roars and plays the theme music from the movie.

About a year ago, a post I made asking for carburetor parts went viral. I had way more work than I could handle. I was able to hire three of my best friends to help. Now we girls are building carburetors as our after-school job. We make all the money we need for gas, our personal projects, insurance and fun.

What are some of the coolest cars for which you've rebuilt the carburetor?

I've done some carbs for really cool cars like a yellow 1972 Pantera, Corvettes, GTOs, Chevilles and a million hot rods – and also for my personal 1966 Ford Fairlane. I get a charge when customers send me pictures of their project cars running. I like to think each carb that goes out is getting another cool old car on the road so people can see it, and so the owner can have some fun.

Do you have a favorite car?

I like sleepers; ratty-looking and dirty on the outside, but really fast and surprising on the inside. My 1966 Fairlane is like that.

What are your future goals?

Right now I'm figuring out how to bring this job with me to college. My soccer coach has given me the okay to bring my equipment with me and set it up in the engineering department. I may be able to hire some of the girls on the team to help me keep it going. I also tune carbs on clients' cars, so I'm looking for some classic car consignment shops in Connecticut to let me come and tune for them.

To see/read more of Schlick-Trask's story, you can follow her on all social media platforms by searching Riley's Rebuilds. ■



DOWNTOWN AUBURN

If you're looking for a special music gift, come see



Kim's Korner Music & More

Instruments · Supplies · Books
Old Vinyl Records · DVDs
Technique books for all instruments
T-shirts · Hats · & More!

211 N. Jackson Street · Auburn, IN 46706
(260) 333-0887

AUBURN ABSTRACT COMPANY INC.

Serving DeKalb County Since 1899

Successors to DeKalb Abstract & Title Co. & Knapp Abstract Inc.

ABSTRACTERS AND TITLE INSURANCE AGENTS

Member of - Indiana Land Title Association



Meghann D. McAfee & Molly K. McAfee-Eddy
Owners

120 W. 8th, Auburn | 925-4260

House of Spirits

Welcome ACD Enthusiasts



Coldest Beer in Town!

Beer - Liquor - Wine

202 S. Union St.
Auburn, Indiana 46706

Locally Owned

Carbaugh

JEWELERS



Tradition



122 years
in business

Offering customers
the unique experience
of shopping
where their great
grandparents shopped.

Located in historic downtown Auburn, Indiana.

108 E. 7th Street, Auburn, IN 46706 · 260-925-3113 · carbaughjewelers.com · f

Discover all that historic downtown Auburn has to offer and support these local businesses. Plus, see the great services Auburn professionals are offering our community.

Helping people. Improving Quality of Life.



team quality services

108 South Jackson, St
Auburn, IN 46706

teamqualityservices.com
1.866.568.TEAM (8326)



QUALITY LIAISONS



INSPECTION & REWORK



MANUFACTURING SERVICES



ENERGY SERVICES







SUPPLIER AUDITS



**MAD ANTHONY'S
AUBURN TAP ROOM**

114 North Main Street Auburn, IN 46706 | ph: (260) 927-0500 | madbrew.com

Events | Showers | Meetings | Receptions | Parties



McIntyre-Place.com | 260.920.7150





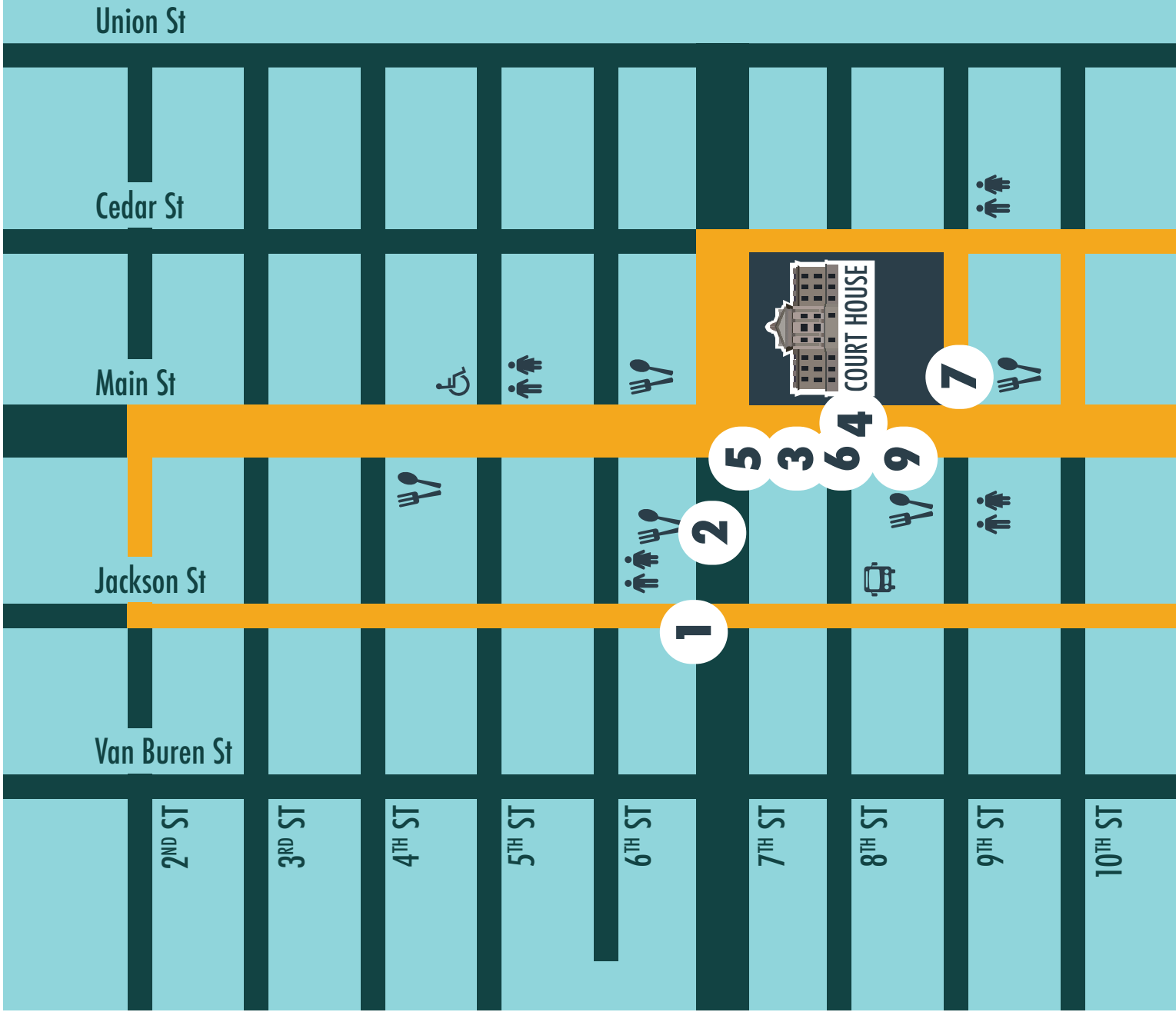

116 South Jackson Street, Auburn, Indiana

Information Key

1. Ticket to Ride
2. Cruise-In Cuisine Food Trucks
3. ACD Fest Downtown Bar
4. Downtown Cruise-In
5. Info Booth
6. Metal X Entertainment Stage
7. Fast & Fabulous
8. ACD Club Car Show (Sept. 2)



9. ACD Club Cars

-  Parade of Classics Route
-  Restrooms
-  Disability Parking
-  Shuttle Stops
-  Gas Stations
-  Restaurants & Bars

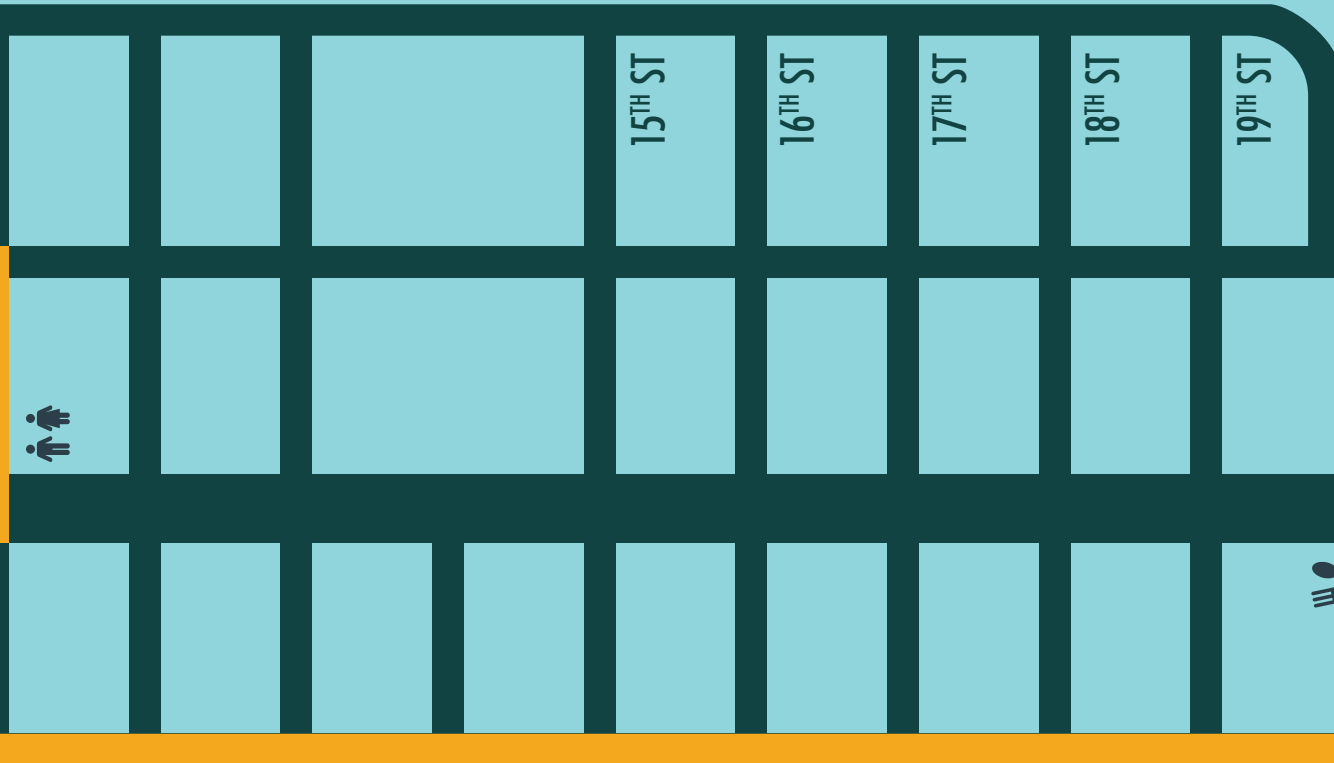

Museum District

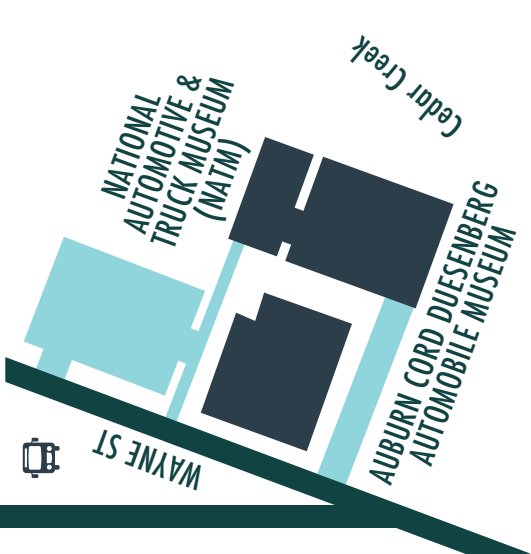

8

Eckhart Park

Wayne St.

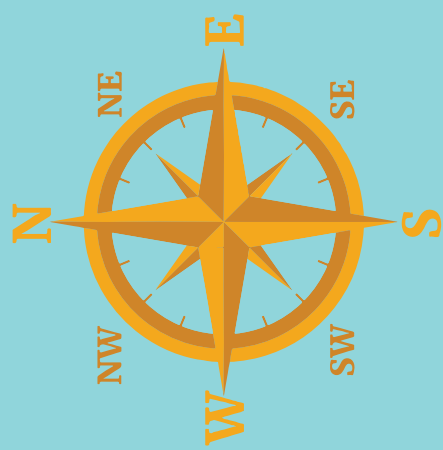

CAR AUCTION, CAR CORRAL & SWAP MEETS



FOR AUCTION, TAKE I-69 EXIT 326 ONTO COUNTY ROAD 11A. FOLLOW SIGNS WEST TO 5634 OPPORTUNITY BLVD.

NORTH MAIN STREET

*Paper
Gourmet*

Purveyor of Whimsy,
Décor & Style

115 N. Main Street
Auburn, Indiana

(260) 927-2222
Find us on 





WE CATER TO YOU

From delicious entrées to homemade desserts, we've got something for everyone. We'll take care of the details, so you can relax and enjoy your party, wedding or special event. You'll like the way we roll!

Give us a call to plan a custom menu and schedule your event today!



Catering ★ Special Events
260-316-3610
 HoosierMamaFT@gmail.com

  **Follow us to find us!**



Unique Clothing (girls up to size 16; boys up to size 14)
Accessories | Toys | & So Much More!

Little Sprouts
CHILDREN'S CLOTHING BOUTIQUE

111 N. Main Street | Auburn, Indiana 46706 | (260) 925-9534 | shoplittlesprouts.com

OPEN EXTENDED HOURS LABOR DAY WEEKEND!

EVENTS CALENDAR

Event times and dates are subject to change. Please check the ACD Festival website at acdfestival.org for the most up-to-date information.



PRE-FESTIVAL EVENTS

SUNDAY, JULY 23

MISS ACD PAGEANT

PRESENTED BY PAGEANT COMMITTEE IN PARTNERSHIP WITH THE ACD FESTIVAL

TIME | 4 p.m.

LOCATION | Kruse Plaza; The Hangar, 5634 Opportunity Drive, Fort Wayne, Indiana

COST | TBD

The road to Miss America begins at the ACD Festival as we crown our very own Miss Auburn Cord Duesenberg! Join us to watch contestants compete for scholarships through various areas of competition, including talent and on-stage interviews. Eligible participants must live, work or attend school in DeKalb, Allen or Steuben counties. Visit missindiana.org for more information and to register.

*Pre-registration is required for participants.

WEDNESDAY, AUG. 23

DANCING WITH THE DEKALB STARS

PRESENTED BY BEACON CREDIT UNION AND THE ACD FESTIVAL

TIME | Dancing begins at 6 p.m.; concert will follow

LOCATION | Country Heritage Winery & Vineyard, 185 County Road 68, LaOtto, Indiana

COST | Free; \$1 per vote directly to the nonprofit of your choosing

You are invited to the 3rd Annual Dancing with the DeKalb Stars, brought to you by Beacon Credit Union and the ACD Festival! This community event invites the area's finest movers and shakers for an evening of friendly competition to raise money for nonprofit organizations serving DeKalb County!

This year's stars include: Liz Braden, 21Alive News Meteorologist; Nora Schwartz, Development Director, Junior Achievement of Northern Indiana; Mark Burnworth, Resource Development Coordinator, United Way of DeKalb County / President, Young Professionals of DeKalb County; Jason Rohrbach, Owner, Heirloom Clock and Fine Art; Jama Smith, Owner and Marketing Director, Littlejohn Auctions / President, Auburn Main Street; Thompson Smith, Attorney, Smith Law Group, PC

This event is sure to keep you entertained! The Wallen Road Band will be taking the stage after the competition, so stick around for live music, great wine, food and even more fun, including raffle baskets up for bid during the evening. Thank you to Fort Wayne Ballroom for providing the lessons, partners and choreography for this event, and to Kent Johnson, the evening's emcee.

SATURDAY, AUG. 26

CHEERS TO THE FESTIVAL, SUPERCHARGED!

PRESENTED BY THE ACD FESTIVAL

TIME | 6 to 9 p.m.

LOCATION | Praxis Detailing/FUEL Social Club,
220 W. Ensley Ave., Auburn

COST | \$50 per person; two drinks included with admission in addition to cash bar

Jumpstart the ACD Festival with us at this year's Cheers to the Festival fundraiser and celebration. Enjoy a night of SUPERCHARGED fun, including cool cars, music, car trivia, theme-inspired cocktails and heavy hors d'oeuvres. Come dressed in your best supercharged themed attire (racing, neo, vintage, etc.) The more over the top, the better! Prizes will be awarded for best outfits.

This is the only place where you can bid on a reserved parking space for Friday's famous downtown Cruise-In as well as a reserved table in the middle of all the action Friday and Saturday nights for the downtown concerts. In addition, secure your chance to ride in style in the Parade of Classics, become the special owner of the 2023 signed ACD Festival poster art and much more. This special live auction is sure to impress! If you love the festival, this event is a must! Reserve your tickets today by visiting acdfestival.org or call (260) 925-3600. For additional information, email leslie@acdfestival.org.

SUNDAY, AUG. 27

ANNUAL GARAGE CRUISE

PRESENTED BY THE ACD FESTIVAL AND NATIONAL AUTO & TRUCK MUSEUM

TIME | 10 a.m. to 4 p.m.

LOCATION | Auburn and surrounding areas

COST | \$10 for entire tour or \$5 per stop

Ever drive by a local garage and wonder what's inside? This is the event for you! Take a Sunday drive and visit the garages and shops of local automotive enthusiasts and business owners for a behind-the-scenes look at their automotive projects and spaces. See car memorabilia, antique signs, street rods, muscle cars, classic autos, specialty trucks and other unique projects. Tour the Garage Cruise locations in any order you choose. Visit the National Auto & Truck Museum at 1000 Gordon Buehrig Place, Auburn, Indiana for tickets or for more information call (260) 925-9100.



TUESDAY, AUG. 29

ANNUAL ACD FESTIVAL HOOSIER TOUR

PRESENTED BY THE ACD FESTIVAL

TIME | 8:30 a.m.

LOCATION | Tour leaves from the Auburn Cord Duesenberg Automobile (ACDA) Museum for a two-day trip throughout the region. This year's tour will head south to visit Anderson and Carmel, Indiana.

COST | Free to spectators; pre-registration required for participants

The Hoosier Tour welcomes 50 Auburns, Cords and Duesenbergs on a traveling tour to promote the ACD Festival and enjoy a variety of fun activities. The tour arrives back at the ACDA Museum on Thursday, Aug. 31, at 11:45 a.m. with a performance by the Dixieland Band. Contact the Festival at information@acdfestival.org. To register, visit our website at acdfestival.org and click on the Hoosier Tour event listing.

WEDNESDAY, AUG. 30

FALL SWAP MEET (VENDOR SET-UP)

PRESENTED BY THE EARLY FORD V-8 FOUNDATION MUSEUM

TIME | 9 a.m. to 5 p.m.

LOCATION | 2181 Rotunda Drive, Auburn, Indiana

COST | Free to spectators; \$25 space rental

Come celebrate Labor Day weekend at the Early Ford V-8 Foundation Museum. Automotive parts, tools and automobilia galore! Space rental (20 ft. x 30 ft.) is \$25 with pre-registration preferred. Visit fordv8foundation.org or call (260) 927-8022 for additional event information, as well as for museum hours and admission prices.

16TH ANNUAL AUBURN AUCTION (PREVIEW)

PRESENTED BY WORLDWIDE AUCTIONEERS

TIME | Doors open at 9 a.m.

LOCATION | Worldwide Auctioneers Headquarters -
5634 Opportunity Blvd., Auburn

COST | Visit worldwideauctioneers.com for more info

View cars and memorabilia in Worldwide Auctioneers' 200,000 square foot climate-controlled auction facility and gallery.

DESTINATION AUBURN CAR CORRAL, AUTOMOTIVE SWAP MEET AND LIFESTYLE VENDORS

PRESENTED BY WORLDWIDE AUCTIONEERS

TIME | 9 a.m. to 6 p.m.

LOCATION | Worldwide Auctioneers Headquarters -
5634 Opportunity Blvd., Auburn

COST | Outside events are free to spectators; visit destinationauburn.com for more information

Shop a select marketplace of the best automotive lifestyle vendors from across the country, and take time to enjoy the on-site car corral and swap meet with fellow enthusiasts.

AUBURN CARS FOR SALE.COM

XTREME

AUTO SALES

260-232-1042

9:00am – 5:30pm Monday – Friday
9:00am – Noon Saturday

GREAT RATES!

SLOW CREDIT | NO CREDIT | NO PROBLEMS

- 1ST TIME BUYER
- SHORT JOB TIME
- BANKRUPTCY
- SELF EMPLOYED
- DIVORCED





Custom Exhaust & Undercar Service, LLC

313 N. Grandstaff Dr. - Auburn, IN 46706

Stock and Custom Exhaust Systems

Brakes - Shocks

Alignment - Suspensions

Darvin & Harry

260-927-0381

MAIN FESTIVAL EVENTS

THURSDAY, AUG. 31

FALL SWAP MEET

PRESENTED BY THE EARLY FORD V-8 FOUNDATION MUSEUM

TIME | 9 a.m. to 5 p.m.

LOCATION | 2181 Rotunda Drive, Auburn, Indiana

COST | Free to spectators; \$25 space rental

Come celebrate Labor Day weekend at the Early Ford V-8 Foundation Museum. Automotive parts, tools and automobilia galore! Space rental (20 ft. x 30 ft.) is \$25 with pre-registration preferred. Visit fordv8foundation.org or call (260) 927-8022 for additional event information, as well as for museum hours and admission prices.

16TH ANNUAL AUBURN AUCTION, DAY 1

PRESENTED BY WORLDWIDE AUCTIONEERS

TIME | Doors open at 9 a.m.; Car and memorabilia auction begins at 11 a.m.

LOCATION | Worldwide Auctioneers Headquarters - 5634 Opportunity Blvd., Auburn

COST | Visit worldwideauctioneers.com for more info

View cars and memorabilia in Worldwide Auctioneers' 200,000 square foot climate-controlled auction facility and gallery. *Auction times are subject to change. Visit worldwideauctioneers.com for the most up-to-date schedule.

DESTINATION AUBURN CAR CORRAL, AUTOMOTIVE SWAP MEET AND LIFESTYLE VENDORS

PRESENTED BY WORLDWIDE AUCTIONEERS

TIME | 9 a.m. to 6 p.m.

LOCATION | Worldwide Auctioneers Headquarters - 5634 Opportunity Blvd., Auburn

COST | Outside events are free to spectators; visit destinationauburn.com for more information

Shop a select marketplace of the best automotive lifestyle vendors from across the country, and take time to enjoy the on-site car corral and swap meet with fellow enthusiasts.

KICK-OFF LUNCHEON AND CELEBRATION

SPONSORED BY THE EARLY FORD V-8 FOUNDATION MUSEUM; PRESENTED BY THE ACD FESTIVAL

TIME | 12 p.m.

LOCATION | ACDA Museum, Willennar Hall

COST | \$20 per person

Join us as we celebrate the official start of the 2023 ACD Festival. View Auburns, Cords and Duesenbergs parked in front of the museum as they return from the Hoosier Tour. Enjoy the sounds of Auburn's own Dixieland Band. Hear highlights of the Hoosier Tour along with updates on festival events and activities. Tickets are required and can be purchased at the ACD Festival office or online at acdfestival.org. Call (260) 925-3600 for more information.

Beacon
CREDIT UNION

Proudly Supports

Auburn Cord Duesenberg Festival



AMERICAN SHARE INSURANCE
Each account insured up to \$250,000.
By member's choice, this institution is not federally insured.

Auburn: 136 W. 7th St. • 715 N. Grandstaff Dr.

(800) 762-3136 | beaconcu.org

THE 9TH STREET EXPERIENCE

PRESENTED BY THE ACD CLUB

TIME | Evening

LOCATION | 9th Street near the Auburn Hotel

COST | Free

Be sure to check out the stars of the show: Auburns, Cords and Duesenbergs of the ACD Club! Don't forget to grab a snack at Martha's Popcorn Stand and check out the beautiful mural while you are there. It's a duesy!

AUBURN CORD DUESENBERG FACTORY MEET AND GREET

PRESENTED BY THE AUBURN MOOSE FAMILY CENTER

TIME | 6 to 11 p.m.

LOCATION | Auburn Moose Family Center,
10th and Main Street

COST | Admission is free; food and drink available for purchase

All are welcome to enjoy vintage, second-generation and special-interest cars while reconnecting with old friends and making new ones!

AUBURN CORD DUESENBERG AUTOMOBILE MUSEUM ANNUAL BENEFIT & CELEBRATION

PRESENTED BY THE AUBURN CORD DUESENBERG AUTOMOBILE MUSEUM

TIME | 6 to 10 p.m.

LOCATION | Auburn Cord Duesenberg Automobile Museum

COST | \$150 per person; individual or corporate sponsorship tables available

The Auburn Cord Duesenberg Automobile Museum is celebrating the preservation and restoration work on the National Historic Landmark building during its annual benefit and celebration – a must attend event for all! The evening is filled with music, entertainment and fun! It begins with hors d'oeuvres and cocktails served in the grand Art Deco Showroom. Following cocktail hour, guests will be ushered by live music to a delicious gourmet dinner, open bar and entertainment. This annual benefit and celebration directly supports the museum and its programs, events and exhibits, and is one of the museum's largest and most important fundraisers of the year. For tickets, sponsorships and more information, call (260) 925-1444 or visit automobilemuseum.org/events/museum-programs.

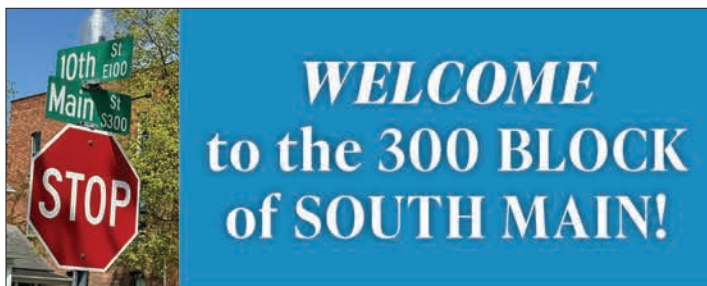

Delightfully unique boutique shopping experiences.



Natural Soaps | Candles | Herbs | Teas
307 & 309 South Main Street
MyNaturesOnline.com



On-Trend Fashion Boutique
Faith + Fashion & Decor
308 South Main Street
f @ForeverEighteenBoutique



Forget Me Not
resale boutique

Upscale Consignment Boutique
310 South Main Street
f @ForgetMeNotDeKalb



FRIDAY, SEPT. 1

PANCAKE AND SAUSAGE BREAKFAST

PRESENTED BY NATIONAL AUTO & TRUCK MUSEUM

TIME | 7 to 10 a.m.

LOCATION | NATM north parking lot

COST | Donations to support the NATM museum are appreciated

Start your day with a hearty breakfast and camaraderie right in the heart of the museum district. Supporting the National Auto & Truck Museum never tasted so good!

ACD CLUB SWAP MEET

PRESENTED BY THE ACD CLUB

TIME | 7 a.m. to 12 p.m.

LOCATION | Auburn Skate Park parking lot near Eckhart Park

COST | Free

Join fellow automotive enthusiasts as you peruse the many auto-related items available.

FALL SWAP MEET

PRESENTED BY EARLY FORD V-8 FOUNDATION MUSEUM

TIME | 9 a.m. to 5 p.m.

LOCATION | 2181 Rotunda Drive, Auburn, Indiana

COST | Free to spectators; \$25 space rental

Come celebrate Labor Day weekend at the Early Ford V-8 Foundation Museum. Automotive parts, tools and automobilia galore! Space rental (20 ft. x 30 ft.) is \$25 with pre-registration preferred. Visit fordv8foundation.org or call (260) 927-8022 for additional event information, as well as for museum hours and admission prices.

16TH ANNUAL AUBURN AUCTION, DAY 2

PRESENTED BY WORLDWIDE AUCTIONEERS

TIME | Doors open at 9 a.m.; Car and memorabilia auction begins at 11 a.m.

LOCATION | Worldwide Auctioneers Headquarters - 5634 Opportunity Blvd., Auburn

COST | Visit worldwideauctioneers.com for more info

View cars and memorabilia in Worldwide Auctioneers' 200,000 square foot climate-controlled auction facility and gallery. *Auction times are subject to change. Visit worldwideauctioneers.com for the most up-to-date schedule.

More than a dental office...

Your dental home.



260-925-3110

1100 N. Main St., Suite 101
Auburn, IN 46706

www.schmidtdental.com

Daniel L. Schmidt, DDS
Andrew C. Schmidt, DDS
Anna R. Marr, DDS

DESTINATION AUBURN CAR CORRAL, AUTOMOTIVE SWAP MEET AND LIFESTYLE VENDORS

PRESENTED BY WORLDWIDE AUCTIONEERS

TIME | 9 a.m. to 6 p.m.

LOCATION | Worldwide Auctioneers Headquarters - 5634 Opportunity Blvd., Auburn

COST | Outside events are free to spectators; visit destinationauburn.com for more information

Shop a select marketplace of the best automotive lifestyle vendors from across the country, and take time to enjoy the on-site car corral and swap meet with fellow enthusiasts.

HAM RADIO SPECIAL EVENT STATION

PRESENTED BY NORTHEASTERN INDIANA AMATEUR RADIO ASSOCIATION (NIARA)

TIME | 9 a.m. to 5 p.m. Friday, Saturday and Sunday

COST | Free

Using their amateur radio stations, NIARA members will be making contacts throughout the United States and internationally honoring the festival through shortwave radio using callsign K9A. Modes of operation will be voice, digital and morse code. Visit w9ou.org for more information.

DOWNTOWN CRUISE-IN

PRESENTED BY THE ACD FESTIVAL

TIME | Vehicle parking and registration begins at 10 a.m. at the north gate (5th and Main Street) and at the south gate (11th and Main Street)

LOCATION | Downtown Auburn, Courthouse Square

COST | \$15 per vehicle; free for spectators

Downtown Auburn is the place to be for the popular Friday ACD Festival Cruise-In. Come display your vehicle in downtown Auburn, as streets are closed for this unique gathering of worldwide visitors, all here to see the diverse mix of automobiles. Previous years have brought in up to 700 cars! Hot rods, muscle cars, imports and everything in between descend upon downtown Auburn for this event. Stroll around the historic Auburn courthouse to take in the sights and sounds of this unique display of automobiles. Check out the 9th Street Experience located between Jackson and Main to see the stars of the show – the Auburns, Cords and Duesenbergs of the ACD Club!



9/1

HELLO, AUBURN!

1st Source is proud to be the official bank of the Auburn Cord Duesenberg Festival.

We are success driven and here to help you navigate your financial journey.



104 South Jackson Street, Auburn
1stsource.com

Member FDIC

AUBURN ARMS

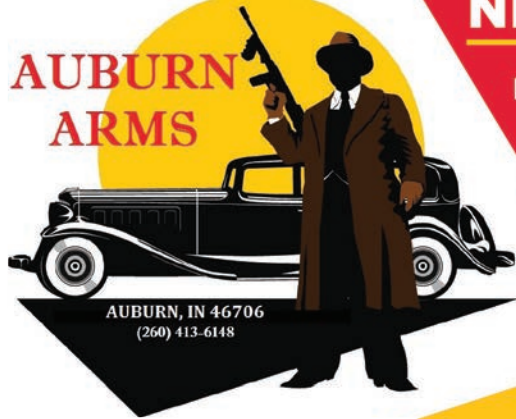

AUBURN, IN 46706
(260) 413-6148

BIG NEWS!

New Local Owners!

New Inventory!

Same Great Location!

Best Prices in Northeast Indiana!

401 W. Auburn Drive | Auburn, IN 46706
(260) 413-6148 | auburnarms.com



SPONSORED BY



5 P.M. - 8 P.M.

JUNE 15	JULY 20	AUG. 17	SEPT. 21
------------	------------	------------	-------------

**FREE FAMILY FUN!
SEE THE CARS!
EAT & SHOP DOWNTOWN!**

FOR MORE INFORMATION,
CONTACT
(260) 925-3600

ACD CLUB DRIVERS' LUNCHEON TOUR PRESENTED BY THE ACD CLUB

TIME | Information pick up 10:30 a.m.; Drivers' meeting 10:45 a.m.; Departure 11 a.m.; Arrival back to ACDA Museum 1 p.m.
LOCATION | 1600 Wayne Street, in front of the ACDA Museum
COST | \$40 per person; \$15 for children; includes lunch

Join the ACD Club as they take a scenic drive through DeKalb County back roads. The tour will make a pit stop for lunch at the historic Spencerville covered bridge before arriving back in Auburn early that afternoon. This tour is open to all Auburns, Cords and Duesenbergs and welcomes modern cars to follow the tour and join for lunch. Pre-registration is required and can be completed at acdclub.org.

FREE SHUTTLE!

IN PARTNERSHIP WITH WORLDWIDE AUCTIONEERS, VISIT DEKALB COUNTY AND THE ACD FESTIVAL

TIME | 12 to 9 p.m.
LOCATIONS | Auburn Cord Duesenberg Automobile Museum Plaza; Worldwide Auctioneers; Auburn Sports Park; corner of 8th Street and Jackson Street downtown. (Look for the SHUTTLE STOP flags near each stop location)
COST | Free

Interested in riding to the auction, museums and the ACD Festival events in downtown Auburn? Catch a ride on the FREE shuttle at one of four designated stops in and around Auburn. The shuttle will travel in a loop that includes all four stops (see shuttle map on page 75).

CRUISE-IN CUISINE

PRESENTED BY THE ACD FESTIVAL

TIME | 12 p.m.
LOCATION | 7th Street between Jackson and Main
COST | Varies by vendor

Check out our Cruise-In Cuisine featuring The Brown House, Street Tacos, Alto Grado Pizza, Kona Ice, Smoking J's, Exotic Tacos, Waterloo Lions Club Burgers & Dogs, Shigs 'N Pit, Ziffle's Zip & Go, One Love, Baby Got S'Mac, Salsa Grille, Who Cut the Cheese, WTFish and more! Be sure to check out our downtown restaurants, too!

SPEAKEASY 2023

PRESENTED BY THE AUBURN MOOSE FAMILY CENTER

TIME | 12 p.m.
LOCATION | Auburn Moose Family Center, located at 10th and Main Streets
COST | Free

Come enjoy food, spirits and a place to relax. Guests are welcome and encouraged.

THE 9TH STREET EXPERIENCE

PRESENTED BY THE ACD CLUB

TIME | Evening

LOCATION | 9th Street near the Auburn Hotel

COST | Free

Be sure to check out the stars of the show: Auburns, Cords and Duesenbergs of the ACD Club! Don't forget to grab a snack at Martha's Popcorn Stand and check out the beautiful mural while you are there. It's a duesy!

NEW! PANEL JAM AUTO ART SHOW

PRESENTED BY THE HOOSIER SLINGERS AND THE ACD FESTIVAL

TIME | Begins at 12 p.m.

LOCATION | Courthouse square event tent

COST | Free for spectators; prices vary for pinstriping of items

Watch the local pinstriping group, Hoosier Slingers, as they use decorative line art techniques while live pinstriping vehicle panels, parts and pieces under the event tent. You won't want to miss these artists at work! Select live-painted items will be auctioned at the MetalX Entertainment Stage at 2:00 p.m. and 5:00 p.m. with proceeds benefitting Inspiration Ministries. Interested in having your own items painted? Bring them downtown during event hours.

OFFICIAL ACD FESTIVAL DOWNTOWN BAR

PRESENTED BY TKDS, INC. WITH A PORTION OF PROCEEDS TO BENEFIT THE ACD FESTIVAL

TIME | Begins at 5 p.m.

LOCATION | Main Street between 7th and 8th Streets

Take in the sights, relax with friends and grab a cold one that comes with an FAK Logistics collector koozie! Mad Anthony's award-winning Auburn Brew will be available, in addition to the 2023 ACD Festival wine bottled by Country Heritage Winery and Vineyard, the bar's famous Freaky Tiki and more. Enjoy the live music and beautiful cars as you wet your whistle while you walk.

*Ages 21 and over permitted

SUNDAES ON FRIDAY ICE CREAM SOCIAL

SPONSORED BY 1ST SOURCE BANK, THE OFFICIAL BANK OF THE ACD FESTIVAL; PRESENTED BY THE ACD FESTIVAL

TIME | 5:30 to 7:30 p.m.

LOCATION | Near the corner of 7th Street and Main Street

COST | \$2 per scoop

Enjoy a delicious sundae, featuring Handel's Homemade Ice Cream, while taking in the sights and sounds of one of Friday's most popular events, the Downtown Cruise-In. Big thanks to 1st Source Bank for sponsoring this event and to its employees for helping serve the sundaes.



CHOICE
PHYSICAL THERAPY

PASSIONATE. PERSONAL. PROFESSIONAL.

IN-CLINIC IN-HOME TELEHEALTH WORKPLACE SOLUTIONS

MONDAY - FRIDAY, 6AM-7PM | SATURDAY, BY APPOINTMENT
(260) 333-0031 | CHOICE-PHYSICALTHERAPY.COM



HEARTLAND
AUTO & TIRE CARE

1629 WAYNE ST. | AUBURN, IN | 260-333-7992



Your new Home is waiting

Call a Mike Thomas REALTOR® today! **260.925.6900**

1560 SHOOK DRIVE AUBURN, IN



B. WEST FLOORING

Family owned and operated for 80 years!

- Carpet
- Wood Floors
- Custom Showers
- Ceramic
- Vinyl
- Laminate

924 W. 15th Street | Auburn, Indiana 46706 | (260) 925-3016

NIGHT AT THE MUSEUM DINNER

PRESENTED BY THE ACD CLUB

TIME | 5:30 to 8 p.m.

LOCATION | Auburn Cord Duesenberg Automobile Museum,
1600 Wayne Street

COST | \$50 per adult; \$20 per child

Enjoy a night at the museum with the ACD Club. A delightful dinner will be provided along with piano music and cars on display. Take a stroll through the museum after dinner, too. Pre-registration is suggested and can be completed at acdclub.org. A portion of the proceeds of this event will benefit the ACDA Museum.

CRUISE-IN CONCERT

PRESENTED BY THE ACD FESTIVAL

TIME | Live music from 6 to 11 p.m.

LOCATION | Courthouse Square on the MetalX

Entertainment Stage

COST | Free

Enjoy live music around the Courthouse Square while you check out the cars and connect with friends. With performances by crowd favorites Sunglasses at Night and the Hubie Ashcraft Band, this lineup is sure to have you dancing in the streets! Thank you to our Stage Sponsor, MetalX, and our Entertainment Sponsor, Nucor!



LOCATED DOWNTOWN AUBURN IN THE BIG WHITE TENT

**AUCTIONS ON THE MAIN STAGE
FRIDAY AT
2PM AND 5PM**

HOOSIER SLINGERS
PRESENTS THE
AUBURN AUTO ART SHOW

**WATCH ARTIST'S PAINT PANELS, PARTS, AND PIECES!
OR**

BRING YOUR OWN MEMORABILIA TO BE BRUSHED!

PROCEEDS BENEFIT: INSPIRATION MINISTRIES FOR MORE INFO GO TO WWW.INSPIRATION-MINISTRIES.ORG

SATURDAY, SEPT. 2

ANNUAL ACD CLUB CAR SHOW

PRESENTED BY THE ACD CLUB

TIME | 7 a.m. to 1 p.m.

LOCATION | Eckhart Park

COST | \$5 for adults; \$3 for children; free for ages 3 and under

Come see 300 classic cars in beautiful Eckhart Park. Food is available in the park with activities for kids from 9:30-11:30 a.m.

FALL SWAP MEET

PRESENTED BY THE EARLY FORD V-8 FOUNDATION MUSEUM

TIME | 9 a.m. to 5 p.m.

LOCATION | 2181 Rotunda Drive, Auburn, Indiana

COST | Free to spectators; \$25 space rental

Come celebrate Labor Day weekend at the Early Ford V-8 Foundation Museum. Automotive parts, tools and automobilia galore! Space rental (20 ft. x 30 ft.) is \$25 with pre-registration preferred. Visit fordv8foundation.org or call (260) 927-8022 for additional event information, as well as for museum hours and admission prices.

16TH ANNUAL AUBURN AUCTION, DAY 3

PRESENTED BY WORLDWIDE AUCTIONEERS

TIME | Doors open at 9 a.m.; Car and memorabilia auction begins at 11 a.m.

LOCATION | Worldwide Auctioneers Headquarters - 5634 Opportunity Blvd., Auburn

COST | Visit worldwideauctioneers.com for more info

View cars and memorabilia in Worldwide Auctioneers' 200,000 square foot climate-controlled auction facility and gallery. *Auction times are subject to change. Visit worldwideauctioneers.com for the most up-to-date schedule.

DESTINATION AUBURN CAR CORRAL, AUTOMOTIVE SWAP MEET AND LIFESTYLE VENDORS

PRESENTED BY WORLDWIDE AUCTIONEERS

TIME | 9 a.m. to 6 p.m.

LOCATION | Worldwide Auctioneers Headquarters - 5634 Opportunity Blvd., Auburn

COST | Outside events are free to spectators; visit destinationauburn.com for more information

Shop a select marketplace of the best automotive lifestyle vendors from across the country, and take time to enjoy the on-site car corral and swap meet with fellow enthusiasts.



Auburn Atrium MarketPlace

106 W. 6th St. Downtown Auburn



Independent Purveyor's of Fine Art,
Gifts, Papers, and Home Goods

www.atriumshops.com
260-927-1326



Tails Bookstore



LOCAL FINE ART
CUSTOM FRAMING • ART SUPPLIES





CAR WASH

Clean & Happy!

AUBURN IN | VAN WERT OH | CELINA OH
www.westwoodwash.com



HAINES, ISENBERGER & SKIBA, LLC
CERTIFIED PUBLIC ACCOUNTANTS

AT HAINES, ISENBERGER & SKIBA, LLC WE PRIDE OURSELVES ON A LEGACY OF QUALITY CLIENT SERVICE WITH A CONGENIAL, HANDS-ON APPROACH. WE ARE A GROWING AND EXPERIENCED CPA FIRM WITH OFFICES IN FORT WAYNE AND WARSAW. WE ARE A FULL-SERVICE ACCOUNTING FIRM DEDICATED TO PROVIDING OUR CLIENTS WITH PROFESSIONAL, PERSONALIZED SERVICES AND GUIDANCE IN A WIDE RANGE OF FINANCIAL AND BUSINESS NEEDS. SIMPLY PUT, WE HAVE THE EXPERTISE, COST STRUCTURE AND CAPACITY TO LOCALLY SERVE YOU.

LISA ISENBERGER
ASSURANCE & VALUATION PRACTICE LEADER

CASSIE DUNN
MANAGING PARTNER

DAVID GOLE
TAX & FORENSIC SERVICE PRACTICE LEADER

4650-S W. JEFFERSON BLVD.
FORT WAYNE, INDIANA 46804
(260) 436-9500
HAINESCPA.COM

VISION SOURCE™
INNOVATIVE EYE CARE

DOUGLAS C. MORROW, O.D. & ASSOCIATES

Auburn Office
1212 N. Main St.
Auburn, Indiana 46706
(260) 925-1916

Garrett Office
100 N. Randolph St.
Garrett, Indiana 46738
(260) 357-6261

VISIONSOURCE-IEC.COM

We make water good for life

Family owned & operated for over 50 years

120 Ensley Ave. | Auburn, IN 46706
(260) 925-4412 | metterswatercare.com



OFFICIAL ACD FESTIVAL DOWNTOWN BAR

PRESENTED BY TKDS, INC. WITH A PORTION OF PROCEEDS TO BENEFIT THE ACD FESTIVAL

TIME | Begins at 9 a.m.

LOCATION | Main Street between 7th and 8th Streets

Take in the sights, relax with friends and grab a cold one that comes with an FAK Logistics collector koozie! Mad Anthony's award-winning Auburn Brew will be available, in addition to the 2023 ACD Festival wine bottled by Country Heritage Winery and Vineyard, the bar's famous Bloody Mary, Freaky Tiki and more!

*Ages 21 and over permitted

CONNECTING RODS LUNCH

PRESENTED BY THE AUBURN CORD DUESENBERG AUTOMOBILE MUSEUM

TIME | 11 a.m.

LOCATION | Auburn Cord Duesenberg Automobile Museum

COST | \$15 per person; reservations are required

Did your parent, grandparent, great-grandparent or acquaintance work for the Auburn Automobile Company, Duesenberg, Inc., Cord Corporation or Auburn-Cord-Duesenberg Company? If so, this is a special luncheon for you to join other people from around the globe with similar connections to the Auburn Cord Duesenberg Automobile Museum! Reservations are required and can be made by contacting the museum at (260) 925-1444 or by visiting automobilemuseum.org/events/museum-programs.

PRE-PARADE ENTERTAINMENT

PRESENTED BY THE ACD FESTIVAL

TIME | 11 a.m.

LOCATION | Courthouse Square

COST | Free

Come and enjoy a performance by the Auburn Community Band as you get ready for the Parade of Classics in the heart of the city. There is no better viewing spot than downtown Auburn!

CRUISE-IN CUISINE

PRESENTED BY THE ACD FESTIVAL

TIME | 12 p.m.

LOCATION | 7th Street between Jackson and Main

COST | Varies by vendor

Check out our Cruise-In Cuisine featuring The Brown House, Street Tacos, Alto Grado Pizza, Kona Ice, Smoking J's, Exotic Tacos, Waterloo Lions Club Burgers & Dogs, Shigs 'N Pit, Ziffle's Zip & Go, One Love, Baby Got S'Mac, Salsa Grille, Who Cut the Cheese, WTFish and more! Be sure to check out our downtown restaurants, too!

FREE SHUTTLE!

IN PARTNERSHIP WITH WORLDWIDE AUCTIONEERS, VISIT DEKALB COUNTY AND THE ACD FESTIVAL

TIME | 12 to 9 p.m.

LOCATIONS | Auburn Cord Duesenberg Automobile Museum Plaza; Worldwide Auctioneers; Auburn Sports Park; corner of 8th Street and Jackson Street downtown. (Look for the SHUTTLE STOP flags near each stop location)

COST | Free

Interested in riding to the auction, museums and the ACD Festival events in downtown Auburn? Catch a ride on the FREE shuttle at one of four designated stops in and around Auburn. The shuttle will travel in a loop that includes all four stops (see shuttle map on page 75).

*Please note that the shuttle will run between the ACDA Museum Plaza, Worldwide Auctioneers and the Auburn Sports Park between 12:00-2:30 p.m. on Saturday. Shuttle service to all four stops will resume after 2:30 p.m. at the conclusion of the Parade of Classics.

PARADE OF CLASSICS

PRESENTED BY THE ACD CLUB AND THE ACD FESTIVAL; SPONSORED BY BEN DAVIS AUTOMOTIVE GROUP

TIME | 1 p.m.

LOCATION | See the parade route on pages 40-41

COST | Free

A fan-favorite ACD Festival event! ACD Club members from around the world drive their magnificent classic cars through the Auburn streets. After the parade, these classics are parked around the Courthouse Square and on 9th Street near the Auburn Hotel for your viewing. This year's Parade of Classics will feature the "Year of the Supercharged Car." See the parade's VIPs including Grand Marshal Corky Coker, in addition to the Baron Brigade Marching Band from DeKalb High School. Keep your eyes peeled for NATM's big red Futurliner #10 as it makes its way down the parade route, too!

THE 9TH STREET EXPERIENCE

PRESENTED BY THE ACD CLUB

TIME | Evening

LOCATION | 9th Street near the Auburn Hotel

COST | Free

Be sure to check out the stars of the show: Auburns, Cords and Duesenbergs of the ACD Club! Don't forget to grab a snack at Martha's Popcorn Stand and check out the beautiful mural while you are there. It's a duessy!



**24HR
EMERGENCY
SERVICE**

GARAGE DOOR
SALES - SERVICE - INSTALLATION
dekalbcountydoor.com
877-260-DOOR (3667)



\$2000.00 off

**a lifetime warranty
energy efficient metal roof
sys with gutters**

(260) 444-7448 | TRI-STATEEXTERIORS.NET



Proud to support the ACD Festival

260 - 235 - 0419 — mmcustomcleaning@reagan.com

SUNFLOWER FESTIVAL

Sept. 2 - 10, 2023
Saturdays Noon - 8 PM
Sundays Noon - 6 PM



CORN MAZE & PUMPKIN PATCH

Sept. 16 - Oct. 29, 2023
Fridays 5 PM - 10 PM
Saturdays Noon - 10 PM
Sundays Noon - 6 PM

Corn Maze, Giant Jumping Pillow, Super Mega Slide, Barrell Roll, Hayrides, Pumpkin Patch, Great Festival Food & more!

amazingfallfun.com

3150 County Road 43 | Waterloo, IN 46793 | (260) 333-2302

You Dream It. We Build It.



Our coast-to-coast network of Authorized Builders are the best in the business. From projects big or small, we work together to offer building products and solutions that bring a customer's dreams to life.



POWERFUL PARTNERSHIPS. POWERFUL RESULTS.

Nucor Building Systems has been a leader in the design and manufacture of custom-engineered metal building systems for over three decades. From commercial, to agricultural or industrial projects, our team of experts and Authorized Builders will ensure your building is custom designed to meet your unique needs. Visit us online at nucorbuildingsystems.com and see for yourself how a Nucor metal building can work for you.

TICKET TO RIDE

SPONSORED BY FORT FINANCIAL CREDIT UNION, PRESENTED BY THE ACD FESTIVAL

TIME | 4 to 5:30 p.m.

LOCATION | 7th Street around the James Cultural Plaza

COST | Free

Experience a free ride in some of the coolest cars around! Multiple cars will be available for rides. All will travel the same predetermined course in the downtown area. Pick up a T2R Fast Pass for a shorter wait and first preference of vehicle at the event. T2R Fast Passes are free and can be retrieved at the Auburn Fort Financial location at 1302 S. Grandstaff Drive beginning Aug. 7.

*Car selection is based on availability; one ride per person

FAST & FABULOUS

POWERED BY SWEETCARS, PRESENTED BY THE ACD FESTIVAL

TIME | 5 to 7 p.m.

LOCATION | Courthouse Square, Downtown Auburn

COST | Free

The ACD Festival proudly welcomes SweetCars and the Fort Wayne Driving Club (FWDC) back to downtown Auburn for the 2023 edition of Fast and Fabulous powered by SweetCars! The fun begins at 4:30 p.m. when 100+ modern exotic and sports cars (Ferraris, Lamborghinis, McLarens, Porsches, Corvettes, Camaros, Mustangs and more!) provided by SweetCars and FWDC begin to fill our SweetStreets around the courthouse square. Watch them arrive in style between 4:30 and 5:00 p.m. Cars will remain on display from 5:00-7:00 p.m.

Bring the family and enjoy a treat from our food truck area while checking out the cars. Still not ready to go home? Stick around and listen to Reload beginning at 6:00 p.m. followed by REKT to rock us well into the night!

Fast and Fabulous has quickly become a can't-miss event on Labor Day weekend at the ACD Festival.

*Show car parking for this event is limited to SweetCars and the FWDC only. No exceptions! Spectator parking is available throughout downtown Auburn

ACD CLUB'S BBQ AT RIEKE

PRESENTED BY THE ACD CLUB

TIM | 6 to 8 p.m.

LOCATION | Rieke Park Pavilions, 1800 N. Indiana Ave., Auburn, Indiana

COST | \$40 per adult; \$20 per child

Have dinner with the ACD Club! (Menu TBD) This event is open to the public. Contact acdclub.org for more information. In the case of inclement weather, the dinner will be held in the Rieke Park Lodge.



FAST & FABULOUS CONCERT
PRESENTED BY THE ACD FESTIVAL

TIME | Live music from 6 to 11 p.m.
LOCATION | Courthouse Square on the MetalX
Entertainment Stage
COST | Free

Enjoy live music around the courthouse square while you check out fabulous cars and connect with friends! Be ready to hear the region's best bands including Reload and RekT. Thank you to our Stage Sponsor, MetalX, and our Entertainment Sponsor, Nucor!

THE GATSBY GALA BALL
PRESENTED BY THE AUBURN CORD DUESENBERG
AUTOMOBILE MUSEUM

TIME | 7 to 11 p.m.
LOCATION | Auburn Cord Duesenberg
Automobile Museum
COST | \$35 for individuals; \$65 for couples

Grab your dancing shoes and flapper dress and dance the night away! Travel back in time to the Roaring 20s with complimentary hors d'oeuvres and a cash bar featuring signature cocktails from the award-winning publication, Cocktails of the Auburn Automobile Company: A Collection of Mixed Drinks. Master the dance floor with the live jazz band and celebrate with friends and family. The rhythm will be swingin', your feet will be tappin' and everyone will be dancin'. Make a statement and take part in a dazzling experience!

NL NUGEN LAW
A PROFESSIONAL CORPORATION

We proudly sponsor the
2022 ACD Festival



Your trusted
Transportation and Logistics
provider since 1979

TAYLOR RENTAL

www.TaylorRentalUSA.com



Party



Equipment



Restrooms



Service

POSTNET

346 N Grandstaff Dr. Auburn In 46706 (260)925-6511



Design
Services



Full-Service
Printing



Packing
& Shipping



SUNDAY, SEPT. 3

NEW! AERO & WING CAR INVITATIONAL

PRESENTED BY NATMUS, VISIT DEKALB AND THE ACD FESTIVAL

TIME | 12 to 3 p.m.

LOCATION | Cars will stage at the ACDA Museum Plaza prior to the event; event will end at Courthouse Square

COST | Free

A NATMUS' Legends of NASCAR event, this invitational will include Aero and Wing cars from regional enthusiasts. The cars will follow a similar route as the Parade of Classics (See map on page 40-41). After the parade, view the cars parked around Courthouse Square. Be sure to visit the National Auto and Truck Museum US's Legends of NASCAR exhibit that includes the Richard Petty #43 car.



ENJOY AUBURN ALL YEAR LONG!

THIRD THURSDAY DOWNTOWN AUBURN CRUISE-INS

PRESENTED BY THE ACD FESTIVAL

DATE | Third Thursday of each month from May to September

TIME | 5 to 8 p.m.

LOCATION | Downtown Auburn around Courthouse Square

COST | Free for cars and spectators

Join us downtown for cruise-in fun through the summer months. Contact the ACD Festival office at (260) 925-3600 or visit acdfestival.org for more information.

92ND ANNUAL DEKALB COUNTY FREE FALL FAIR

DATE | Sept. 25 to Sept. 30, 2023

LOCATION | Downtown Auburn and DeKalb County Fairgrounds

COST | Events are free

Enjoy carnival rides, foods, games, national and local entertainment, 4-H and livestock shows, parades and tractor pulls, not to mention Indiana's largest merchant tent. For more information, visit dekalbcountyfair.org.

SUNDAY, SEPT 3RD • 6PM-10PM

FOOD
TRUCKS

GAMES
AND
DOOR
PRIZES



BOUNCE
HOUSES

TONS OF
FAMILY
FUN

FIREWORKS DISPLAY AT DARK
www.dayspringchurch.com

TWO AMAZING VENUES UNDER ONE ROOF!

OPEN 7 DAYS
A WEEK

Mitchell's

SPORTS & Neighborhood Grill

FAMILY ★ FOOD ★ SPORTS ★ SPIRITS

GOLF SUITE OPEN
DAILY AT 10AM



PATIO DINING



LIVE ENTERTAINMENT



GOLF SUITE



MONDAY - THURSDAY 4PM - 11PM
FRIDAY - SATURDAY 11AM - 3AM
SUNDAY 11AM - 11PM
MITCHELLSFW.COM

GREAT FOOD • FUN • ENTERTAINMENT

KNOCKINBOOTSFW.COM

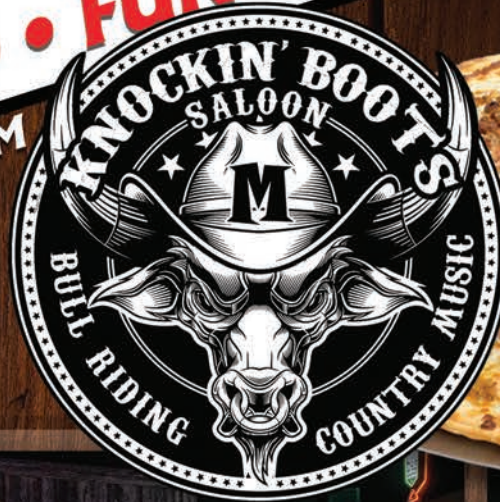

ENTERTAINMENT



BULL RIDING



AXE THROWING

KNOCKIN' BOOTS SALOON:
THURSDAY 5:00PM-1:00AM
FRIDAY-SATURDAY 4:00PM-3:00AM

(260)387-5063

BULLSEYE AXE THROWING & BULL RIDING
MONDAY-THURSDAY 4:00PM-10:00PM
FRIDAY-SATURDAY 11:00AM-1:00AM
SUNDAY 11:00AM-10:00PM

6179 W JEFFERSON BLVD · FORT WAYNE, IN 46804

FIRST FRIDAYS

PRESENTED BY AUBURN MAIN STREET

DATE | **First Friday of each month all year long**

LOCATION | **Downtown Auburn**

Join us in downtown Auburn on the first Friday of each month for extended shopping hours, family-friendly fun and unique experiences. Each month will have a different theme and great fun!

DEKALB OUTDOOR THEATER

DATE | **May through September**

TIME | **Varies**

LOCATION | **Center Street just south of 15th Street**

Hosting cultural, educational and entertainment activities all summer long! Check out dekalboutdoortheater.org for a full schedule of events.

DABA ANNUAL ART DISPLAY

PRESENTED BY DOWNTOWN AUBURN BUSINESS ASSOCIATION (DABA)

DATE | **June through September**

LOCATION | **Downtown Auburn Business District**

DABA works to create an outdoor art display that is unique and whimsical, featuring local artists who share

their talents while supporting downtown Auburn. The 2023 art exhibit, "Elevate Summer in Auburn 2023," will feature 20 elevated garden boxes placed in downtown Auburn. Visit daba4auburn.org for more information.

DOWNTOWN AUBURN FARMERS MARKET

DATE | **May through October each year**

DAY/TIME | **Wednesdays and Saturdays, 7 a.m. to 1 p.m.**

Visit daba4auburn.org for more information and if interested in being a vendor.

CHRISTMAS PARADE

PRESENTED BY THE DOWNTOWN AUBURN BUSINESS ASSOCIATION (DABA)

DATE | **Tuesday before Thanksgiving**

LOCATION | **Courthouse Square**

Enter a float, dance group, horse drawn wagon/sleigh, car, choir, band, civic organization, church group, school group, etc. No Santas or Mrs. Claus', please! Use lights and make your entry shine! For more information visit daba4auburn.org. ■

4

GREAT BRANDS

1

GREAT LOCATION



1

GREAT NAME



HUGE SELECTION | HUGE SAVINGS | AMAZING LEASE OFFERS WHERE THE OIL CHANGES ARE INCLUDED FOR THE LIFE OF THE LEASE!!



Auburn, IN behind the Kroger on Grandstaff
(260) 925-4200 | shepherdsdjr.com |   



PLAN YOUR VISIT!

OPEN YEAR-ROUND!

**AWESOME GIFT SHOP!
UNIQUE MONSTER TRUCK ITEMS & APPAREL**

MONSTER TRUCK MUSEUM!



MONSTER MUSEUM.ORG

FIND US ON FACEBOOK!



**Spring & Fall
Monster Truck Shows**



**SPECIAL EVENTS
PRODUCED THROUGHOUT THE YEAR!**



**Monster Truck Museum Hall of Fame
Induction Ceremony and Reunion**



**Toys/Collectibles
& Memorabilia
Trade Expo**



**Christmas
with Monster Trucks
& Santa**

FRIENDS OF THE FESTIVAL

In memory of Steve Allen	Jim and Ann Finchum	John and Lorrie Pontius	Travis and Julia Sprouse
In memory of Roger Jernigan	Marty Fowler	Robert Probst	Tim and Amy Straley
In memory of Cindy Murfield	George Glaze	Kim Randinelli	David Turner
In memory of Oscar Roberts	Jackie Henderson	Ruth Randinelli	Clay and Cecile Weir
In memory of George Witwer, ACD Festival Director Emeritus	Bill and Mary Hohler	Dawn and Bob Rathgaber	Chris Wells
Troy and Kari Ackerman	William Cord Hummel	Paul Richardson	Jordan Yarde
Brandon Anderson	Ed and Carolyn Kase	Mitchell and Julie Schultz	Eric Zeller ■
George Balunek	John and Abby Kruse	Thompson and Jama Smith	
Jack Bassett	Andy and Dede LaRowe		
Nina Bennett	Jay and Deb Lawson		
John Bools	Pat and Kathy Leahy		
Mike and Joyce Boswell	Tom and Jill Lee		
Tim Butler	Josh and Meg Littlejohn		
Amber Caccamo	Dan and Joan McFarland		
William Chew	John Maloy		
Tyler Cleverly	Patti McGill		
Jim and Janet Clyde	Belva and Sid Meyer		
Josh Conrad	Cameron and Mary Moore		
Daisy Cook	Betty Owens		
Jacob and Natalie DeWitt	Mike and Sarah Payne		
Damian and Cassie Dunn	Kerry and Leslie Peel		
The Dickman Family	Tom and Amanda Peet		
	Cameron Petersen		
	Glenn Petersen		



2022-23

BUSINESS FRIENDS OF THE FESTIVAL

DUESENBERG LEVEL

Ambassador Enterprises

Haines, Isenbarger & Skiba, LLC

Nugen Law

Auburn Abstract Company, Inc.

Heartland Auto North

PostNet

Auburn Arms

House of Spirits

TruCare

B. West Flooring

Likes Law Office

Vision Source Innovative Eyecare

Bohren Logistics

Mettert's Water Care

Choice Physical Therapy

Mike Thomas Realty

CORD LEVEL

Auburn Hills Vet Clinic

CCT Enterprises

KDZ Inc.

Auburn Manufacturing

Community State Bank

Lake City Bank

Bassett Office Supply

Custom Coating, Inc.

Morgan Hefty State Farm

Brian's Automotive/Greatwater
360 AutoCare

Donavan Insurance

Rieke Corp.

Buch's Insurance Agency

Four Seasons Lawnscape Inc.

The Seigel Group

Business Impressions

Good Valuation

Campbell & Fetter Bank

Hometown Graphics

AUBURN LEVEL

Auburn Cord Duesenberg
Automobile Museum

Early Ford V-8 Foundation Museum

Mai Nails

Bo Doogie's

Flagstar Bank

Martha's Popcorn

Brown and Brown Insurance

Garrett State Bank

Max Platt Ford Lincoln

The Brown House

Guitar Infirmary

Mimi's Retreat

The Chop Shop

Insurance & Financial Services

National Automotive and
Truck Museum (NATMUS)

Classic City Automotive

International Monster Truck
Museum & Hall of Fame

Pizza Forum

Classic City Body & Paint

Jeff's Auto Repair & Towing

RP Wakefield/Auburn Hardwood Mouldings

Classic City Signs

Jimelle Flooring

Star Technology

Cricket's 7th Street Bar & Grille

Kim's Korner Music & More

Town Tavern

Deli on 6th and Main/Hoosier
Mama Food Truck

M & M Custom Cleaning

Visit DeKalb ■

THE SCENE

CHEERS TO THE FESTIVAL, SUPERCHARGED!

PRESENTED BY THE ACD FESTIVAL

DATE | Saturday, Aug. 26

TIME | 6 to 9 p.m.

LOCATION | Praxis Detailing/
FUEL Social Club, 220 W.
Ensley Ave., Auburn

COST | \$50 per person
(Two drinks included with
admission, in addition to cash bar)

ATTIRE | Supercharged
themed attire encouraged!

Jumpstart the ACD Festival with us at this year's Cheers to the Festival fundraiser and celebration. Enjoy a night of SUPERCHARGED fun, including cool cars, music, car trivia,

theme-inspired cocktails and heavy hors d'oeuvres. Come dressed in your best supercharged themed attire (racing, neo, vintage, etc.) The more over the top, the better! Prizes will be awarded for best outfits.

This is the only place where you can bid on a reserved parking space for Friday's famous downtown Cruise-In as well as a reserved table in the middle of all the action Friday and Saturday nights for the downtown concerts. In addition, secure your chance to ride in style in the Parade of Classics, become the special owner of the 2023 signed ACD Festival poster art and much more. This special live auction is sure to impress! If you



love the festival, this event is a must! Reserve your tickets today by visiting acdfestival.org or call (260) 925-3600. For additional information, email leslie@acdfestival.org.



PAINT
PROTECTION
FILM



WINDOW
TINT



DENT
REMOVAL



CAR
CLUB



220 W. Ensley Ave.
Auburn, Indiana 46706

(260) 333-7887
praxisdetailing.com

FUEL
SOCIAL CLUB

Bring Your Home Back to Life & Maintain the Beautiful Architectural Design

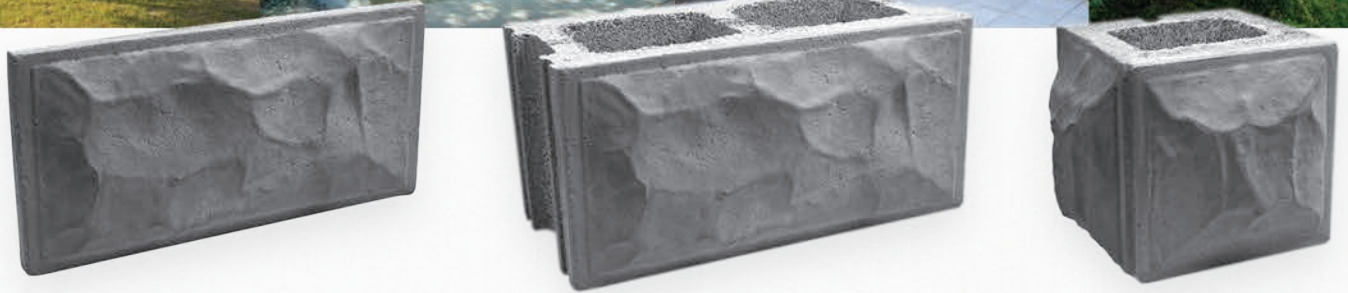

Historic Block Design *from* Original Castings

1623 S. Indiana Ave., Auburn, IN
888-960-8302
classicrockfaceblock.com

Classic
ROCK FACE BLOCK™

DURA
PAV™

Hydra Pressed
Paver Slabs

Durapav.com

DOWNTOWN CRUISE-IN

PRESENTED BY THE ACD FESTIVAL

DATE | Friday, Sept. 1

TIME | Gates open at 10 a.m. to begin vehicle parking. Vehicles should enter at the north gate (5th and Main Street) or at the south gate (11th and Main Street)

LOCATION | Downtown Auburn, Courthouse Square

COST | \$15 per vehicle; free for spectators

Bring your vehicle for display in the Home of the Classics. The downtown Auburn streets are closed for this diverse mix of automobiles. Previous years have brought up to 700 cars to this event! Hot rods, muscle cars, imports

and everything in between will be on display around Courthouse Square.

Check out the 9th Street Experience, located between Jackson and Main, to see the stars of the show – the Auburns, Cords and Duesenbergs of the ACD Club!

Cruise-In entry gates are located on north Main Street near 5th Street, as well as south Main Street near 11th Street.

No prior registration required. Vehicles entering at the gates will receive a limited-edition ACD Festival 2023 dash plaque while supplies last.

*For the safety of all in attendance, do not drive around barricades.

Stick around into the evening to enjoy free live music on the MetalX



Entertainment Stage at courthouse square while you check out the cars. Sunglasses at Night will take the stage at 6:00 p.m. with the Hubie Ashcraft Band finishing out a jam-packed Festival Friday! Thank you to our Entertainment Sponsor, Nucor! ■



SMITH LAW GROUP

A PROFESSIONAL CORPORATION, AUBURN, INDIANA

(260) 925-4560

Thompson Smith Attorney

507 S. Jackson St Auburn, IN 46706



THE ACD FESTIVAL PRESENTS



SUNGLASSES AT NIGHT



HUBIE ASHCRAFT BAND



RELOAD



REKT

JOIN US FOR TWO NIGHTS OF FREE FAMILY-FRIENDLY FUN!

ALL PERFORMANCES WILL TAKE PLACE ON THE **METALX** ENTERTAINMENT STAGE AT 8TH AND MAIN.

FRIDAY SEPT. 1 - CRUISE-IN CONCERT

SUNGLASSES AT NIGHT6PM
 HUBIE ASHCRAFT BAND8:20PM

SATURDAY SEPT. 2 - FAST & FABULOUS CONCERT

RELOAD6PM
 REKT8:15PM

FRIDAY: CRUISE-IN • SUNDAES ON FRIDAY ICE-CREAM SOCIAL • PANEL JAM – **NEW!**
 SATURDAY: PARADE • FAST & FABULOUS • TICKET TO RIDE
 FOOD TRUCKS BOTH DAYS



FOR A COMPLETE LIST OF FESTIVAL EVENTS,
 PLEASE VISIT US AT ACDFESTIVAL.ORG

TITLE SPONSOR



FAST & FABULOUS SPONSOR



ICE CREAM SOCIAL SPONSOR



TICKET TO RIDE SPONSOR



PARADE OF CLASSICS SPONSOR



ENTERTAINMENT SPONSOR



SOUND SPONSOR



PARADE OF CLASSICS

PRESENTED BY THE ACD FESTIVAL

DATE | Saturday, Sept. 2

TIME | 1 p.m. (pre-parade entertainment begins at 11 a.m.)

LOCATION | Through downtown Auburn from Eckhart Park

COST | Free

A fan-favorite ACD Festival event! ACD Club members from around the world drive their magnificent classic cars through the Auburn streets – with review at the courthouse square – on Saturday, Sept. 2, beginning at 1:00 p.m. After the parade, these classics are parked around the courthouse square for your viewing, and on 9th Street

near the Auburn Hotel. What a great opportunity to get an up-close view of these beauties while also getting a chance to chat with the owners. This year's Parade of Classics will feature the "Year of the Supercharged Car."

Pre-parade entertainment by the Auburn Community Band begins at 11:00 a.m. The Baron Brigade Marching Band, parade dignitaries including our Grand Marshal Corky Coker, and NATMUS' Futurliner #10 will lead the way for the ACD Club classics rolling through at 1:00 p.m. Prior to the parade, you can view these cars at Eckhart Park beginning at 7:00 a.m. These beautiful



PHOTOGRAPHY BY DANIEL CHURCH

Auburns, Cords and Duesenbergs are a sight you won't want to miss!

*See the parade route on the ACD Festival map on pages 40-41 ■

GET IN TOUCH

Contact our Sales Department
(855) 366-5595

Ben Davis

Official Sponsor of the Parade of Classics

931 W. 7th St. | Auburn, IN 46706
bendavischevrolet.com

Discover

Pokagon State Park and Trine State Recreation Area



A world of outdoor fun and activity awaits you at Pokagon State Park and its adjacent property, Trine State Recreation Area. You can fish off the special pier or rent a kayak, paddleboat, or trolling motor powered rowboat. Our single and duplex cabins are air conditioned and have kitchenettes, plus a GREAT view of the lake. Your admission to Trine State Recreation Area also gains you entrance into Pokagon State Park, where many other activities await, such as horseback rides, long trails, swimming beaches, and a nature center. You owe it to yourself to discover Northern Indiana Lakes Country!



 **Steuben County Tourism Bureau**
lakes101.org



Potawatomi Inn is also located inside Pokagon State Park.

TICKET TO RIDE

PRESENTED BY THE ACD FESTIVAL

DATE | Saturday, Sept. 2

TIME | 4 to 5:30 p.m.

LOCATION | 7th Street around
the James Cultural Plaza

COST | Free

Join us for the third annual Ticket to Ride event! At this fan-favorite event, visitors can enjoy a free ride in a classic car. The mission of Ticket to Ride is to bridge the gap between classic and luxury car owners and the community to help keep car culture alive in Auburn. Thank you to our generous sponsor, Fort Financial!

Multiple cars will be available for rides. All will travel the same predetermined course in the downtown area. Pick up a T2R Fast Pass for a shorter wait and first preference of vehicle at the event! T2R Fast Passes are free and can be picked up at the Fort Financial Auburn location at 1302 S. Grandstaff Drive beginning Aug. 7. (Fast Pass tickets are limited)

Thanks to the following supporters for providing cars and drivers for this event: ACDA Museum, ACD Club, NATM, Early Ford V-8 Foundation Museum, Get Bent and ACD Festival board members.

Be sure to follow the ACD Festival on Facebook for event updates! Have



questions? Call the ACD Festival office at (260) 925-3600 or email information@acdfestival.org. ■



Fortify your banking relationship.

Life can force you to make difficult decisions. Choosing your banking partner shouldn't be one of them. We're committed to making it easy. When you choose Fort Financial, you can expect:

- Deep local roots dating back more than 75 years
- A banking team committed to understanding you, your goals and your needs
- Expert guidance and personalized coaching
- 100% locally-made business banking decisions
- A strong commitment to strengthening Northeast Indiana

No matter what your financial goals are, we're ready to help. Let's talk about how we can help *fortify your life*.



Fort Wayne | Churubusco | Auburn | Angola
260.432.1561 | fortfinancial.org

Federally insured by the NCUA. Equal Housing Lender.



Shop | Explore | Taste Downtown Auburn

AuburnMainStreet.org

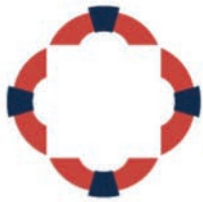

AUBURN DOWNTOWN
MAIN STREET AUBURN
— AUBURN, IN — BUSINESS
ASSOCIATION



AWARD WINNING WINE

HARTLAND WINERY



THE KITCHEN ^{AT} HARTLAND WINERY



SMALL BATCH ^{AND} HANDCRAFTED

FREE WINE TASTING
OUTDOOR SEATING
QUIET SETTING

WED-THURS: 12PM-6PM
FRI & SAT: 12PM-8PM
SUN: 1PM-5PM

WOOD FIRED PIZZA
SANDWICHES
SALADS
CHARCUTERIE

HOURS
FRI: 5PM-7:30PM
SAT: 12PM-7:30PM
SUN: 1PM-4:30PM

IN THE HEART
OF IT ALL

425 COUNTY ROAD 23, ASHLEY, IN 46705

260-587-3301

HARTLANDWINERY.COM

FAST AND FABULOUS

PRESENTED BY THE ACD FESTIVAL

DATE | **Saturday, Sept. 2**

TIME | **5 to 7 p.m.; Concerts
from 6 to 11 p.m.**

LOCATION | **Downtown Auburn,
around Courthouse Square**

COST | **Free**

The ACD Festival proudly welcomes SweetCars and the Fort Wayne Driving Club (FWDC) back to downtown Auburn for the 2023 edition of Fast and Fabulous powered by SweetCars! The fun begins at 4:30 p.m. when 100+ modern exotic and sports cars (Ferraris, Lamborghinis, McLarens, Porsches, Corvettes, Camaros, Mustangs and

more) provided by SweetCars and FWDC begin to fill the SweetStreets around the courthouse square. Watch them arrive in style between 4:30-5:00 p.m. The cars will be on display from 5:00-7:00 p.m.

Bring the family and enjoy a treat from our food truck area while checking out the cars. Still not ready to go home? Stick around and listen to Reload beginning at 6:00 p.m. followed by REKT who will rock us well into the night.

Fast and Fabulous has quickly become a can't-miss event on Labor Day weekend at the ACD Festival.



*Show car parking for this event is limited to SweetCars and the FWDC only. No exceptions! Spectator parking is available throughout downtown Auburn. ■

THERMA TRU® DOORS

WORLDWIDE AUBURN AUCTION

AUGUST 31 - SEPTEMBER 2, 2023



2021 Ford GT Carbon Series

3-Day Collector Car Auction & Memorabilia Auction

Worldwide Auctioneers | 5634 Opportunity Blvd., Auburn, IN | WorldwideAuctioneers.com | 260.925.6789

Be a Part of the Longest-Running Collector Car Auction Destination



- ★ Automotive Swap Meet ★
- ★ Automotive Lifestyle Vendors ★
- ★ Car Corral ★
- ★ Food Vendors ★
- ★ FREE Ample Parking ★



BASIC INFORMATION

The *Auburn* magazine is the most complete source of ACD Festival information. For up-to-date changes or questions, contact the ACD Festival office at (260) 925-3600. Visit acdfestival.org and follow us on social media for more information.



ACD FESTIVAL OFFICIAL MERCHANDISE

The ACD Festival's annual poster, created by local artist Amanda Peet, is depicted on t-shirts and various merchandise. These items and more are available at the ACD Festival Information Tent at the corner of 7th and Main Street. Official ACD Festival merchandise, as well as a variety of other unique items, can also be found at the Auburn Cord Duesenberg Automobile Museum store, and at its booth near 9th Street and Main Street. Only items purchased at these sites benefit the ACD Festival and the ACDA Museum, respectively.

PARKING

Ample parking is available throughout downtown and into neighboring residential areas. Select areas will be reserved at times depending on events and will be clearly marked in those instances. If a vehicle is parked in a reserved or restricted area without permission, it will be towed at the owner's expense. Drop-off for disabled patrons is at the corner of 9th

and Jackson Street, as well as Ambassador Enterprises' parking lot at the corner of 5th Street and Main Street (310 N. Main Street). Signs will be posted.

For the safety of all attending, do not drive around barricades.

FREE SHUTTLE SERVICE

will run Sept. 1 & 2 to four designated stops (see shuttle map on page 75). Look for the SHUTTLE STOP flags near each location.

Friday, Sept. 1: 12 to 9 p.m.

Saturday, Sept. 2: 12 to 2:30 p.m. (between the ACDA Museum Plaza, Worldwide Auctioneers and the Auburn Sports Park only); 2:30 to 9 p.m. service will resume between all four stops.

Overnight parking is restricted at the ACDA Museum and Plaza.

RESTROOMS

Restroom facilities are located in the following areas: Near 7th Street and Jackson Street; near 5th and Main Street; Main Street and 11th Street; near the police station on Cedar Street and 9th

Street; 9th Street between Main Street and Jackson Street next to Martha's Popcorn. See map on pages 40-41 for locations.

*For the safety of all of our visitors, please refrain from attending ACD Festival events if you are ill, have COVID-19 symptoms, have tested positive for COVID-19, and/or have been exposed to someone with symptoms or someone with suspected or confirmed COVID-19.

PROHIBITED ITEMS

For the safety of our guests and their property, we prohibit drones*, pets, bicycles, skateboards, scooters, unauthorized vendors, golf carts and weapons. Contact the ACD Festival office with questions.

*It is against FAA regulations, and therefore illegal, to fly drones in the downtown Auburn area during the festival. If found in violation, you may be prosecuted.

IMPORTANT PHONE NUMBERS

In case of emergency,

please dial 911. For non-emergency questions or concerns, please contact:

ACDA Museum
(260) 925-1444

ACD Festival Office
(260) 925-3600

Auburn Fire Department
(260) 920-3200

Auburn Police Department
(260) 920-3200

DeKalb County Sheriff
(260) 925-3365

DeKalb County Visitors Bureau
(260) 927-1499

Early Ford V-8
Foundation Museum
(260) 927-8022

Parkview DeKalb Hospital
(260) 925-4600

National Auto & Truck Museum
(260) 925-9100

Worldwide Auctioneers
(260) 925-6789

For information regarding the Auburn Auction hosted by Worldwide Auctioneers, including the swap meet & car corral, visit worldwideauctioneers.com.

TITLE SPONSOR



SDI

SATURDAY SPONSOR

SWEETCARS-FAST AND FABULOUS

SPONSORS

COUNTRY HERITAGE WINERY AND VINEYARD INC.

KEETA

MEDIACOM

PRAXIS DETAILING / FUEL SOCIAL CLUB

TKDS, INC.

WORLDWIDE AUCTIONEERS

EVENT SPONSORS

BEN DAVIS AUTOMOTIVE GROUP - PARADE OF CLASSICS

BUSHEY'S WINDOWS & DOORS - SATURDAY EVENT TENT

EARLY FORD V-8 FOUNDATION MUSEUM - KICK-OFF LUNCHEON AND CELEBRATION

DEKALB COUNTY VISITORS BUREAU / VISIT DEKALB - HOOSIER TOUR

FAK LOGISTICS - KOOZIES

FCI CONSTRUCTION - VOLUNTEER AND BOARD MEMBER T-SHIRTS

1ST SOURCE BANK - SUNDAES ON FRIDAY ICE CREAM SOCIAL

FORT FINANCIAL - TICKET TO RIDE

METALX - ENTERTAINMENT STAGE

NUCOR - ENTERTAINMENT

OAK PARTNERS - VIP TENT



Complimentary Shuttle

Powered by **WORLDWIDE AUCTIONEERS**

**Friday & Saturday, September 1 & 2
Noon - 9 PM EST**

Shuttle Stops - Key

A | Worldwide Auctioneers

Free Parking, The Auburn Auction, Automotive Swap Meet & Lifestyle Vendors, Car Corral, Early Ford V-8 Museum

B | Auburn Sports Park

Free Parking

C | Museum District

Auburn Cord Duesenberg Automobile Museum, National Auto & Truck Museum (NATMUS)

D | Downtown : W. 8th / S. Jackson St. Corner

ACD Festival Activities and Events

For More Shuttle Information Visit
DestinationAuburn.com/shuttle

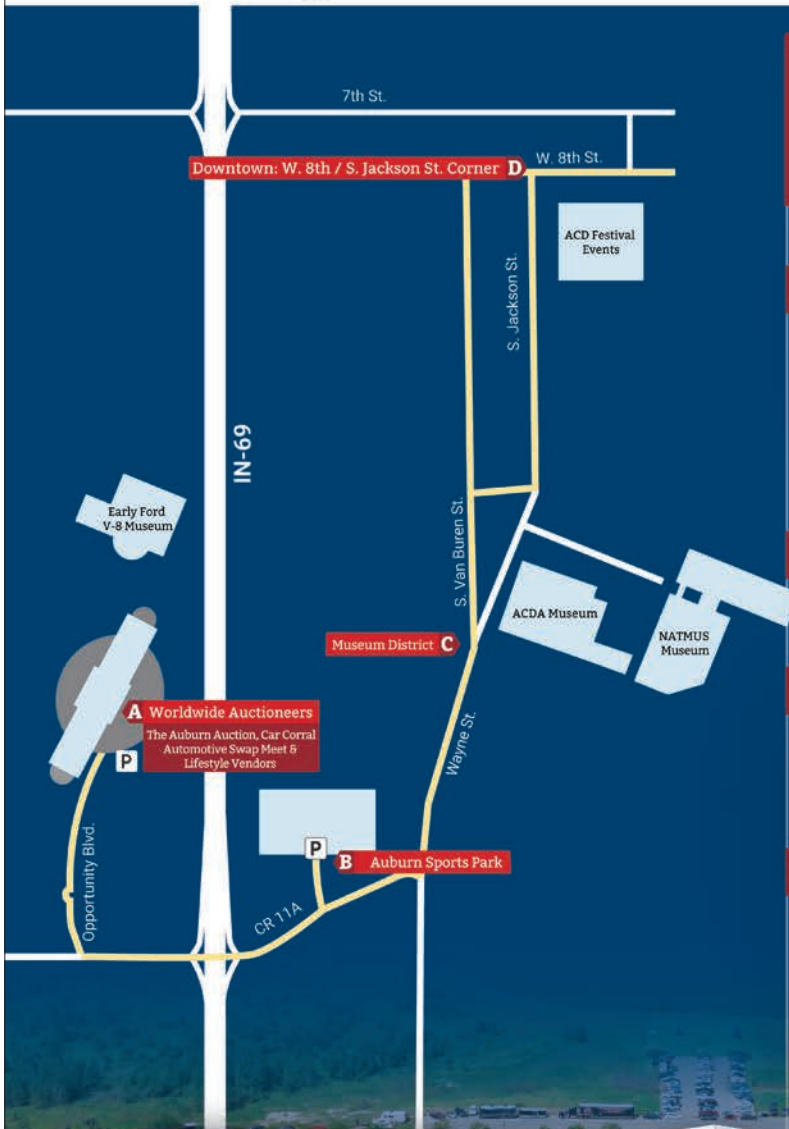

Worldwide Auctioneers | 5634 Opportunity Blvd., Auburn, IN | WorldwideAuctioneers.com | 260.925.6789

Roderick C. Egan, Auctioneer - IN License #AU10000207 • John Kruse, Auctioneer - IN License #AU19900072 • Worldwide Auctioneers Company License #AC31400111

ADVERTISER DIRECTORY

AUTOMOTIVE

- 68
Ben Davis Automotive Group
- 46
Get Bent
- 51
Heartland Auto & Tire Care
- 64
Praxis Detailing
- 60
Shepherd's Family Auto Group
- 34, OBC
SweetCars, LLC
- 73
Worldwide Auctioneers
- 45
Xtreme Auto Sales

BUSINESS / MISC.

- 49
1st Source Bank
- 38
Auburn Abstract Company, Inc.
- 26
Auburn Essential Services
- 51
B. West Flooring
- 46
Beacon Credit Union
- 57
Bohren Logistics, Inc.
- 11
Bushey's Windows & Doors
- 79
Business People Magazine
- 65
Classic Rock Face Block
- 55
DeKalb Co. Door
- 21
F&M Bank
- 28, IBC
FAK Logistics, Inc.
- 70
Fort Financial Credit Union
- 54
Haines, Isenbarger & Skiba, LLC
- 15
Keeta
- 55
M&M Custom Cleaning
- 39
McIntyre Place
- 80
Mediacom
- 54
Mettert's Water Care
- 51
Mike Thomas Realtors
- 57
Nugen Law
- 25
Oak Partners, Inc.
- 57
PostNet
- 66
Smith Law Group, PC
- 57
Taylor Rental
- 39
Team Quality Services
- 72
Therma-Tru Doors
- 55
Tri-State Exteriors
- 54
Westwood Car Wash

HEALTH CARE

- 33
Allendale Treatment
- 48
Auburn Dental Associates

- 51
Choice Physical Therapy
- 54
Vision Source

RESTAURANT, FOOD & BEVERAGE

- 21
Country Heritage Winery and Vineyard
- 27
Gays Hops-N-Schnapps
- 71
Hartland Winery
- 38
House of Spirits
- 39
Mad Anthony Brewing Company
- 59
Mitchell's Sports & Neighborhood Grill
- 42
The Deli at Sixth & Main / Hoosier Mama Food Truck
- 32
The Italian Grille

MANUFACTURING

- 32
FCI Construction
- 35
MetalX
- 56
NUCOR Building Systems
- 3
Shawnee Construction & Engineering
- IFC, 17, 18-19
Steel Dynamics, Inc.

SHOPPING

- 53
Auburn Atrium
- 50
Auburn Arms

- 38
Carbaugh Jewelers

- 47
Forever Eighteen

- 47
Forget Me Not

- 38
Kim's Korner Music & More

- 42
Little Sprouts

- 42
Paper Gourmet

- 47
Nature's Mercantile

TOURISM & ENTERTAINMENT

- 55
Amazing Fall Fun

- 1
Auburn Cord Duesenberg Automobile Museum

- 71
Auburn Main Street & DABA

- 29
City of Angola

- 58
Dayspring Community Church

- 2, 77
DeKalb County Visitors Bureau

- 5
Early Ford V-8 Foundation Museum

- 52
Hoosier Slingers

- 61
International Monster Truck Museum and Hall of Fame

- 7
National Auto & Truck Museum (NATMUS)

- 69
Steuben County Tourism Bureau



Legends OF NASCAR

AUBURN, INDIANA

**NATIONAL
Auto & Truck
MUSEUM**
AUBURN, INDIANA



AERO & WING CAR INVITATIONAL

SUNDAY OF LABOR DAY WEEKEND

SEPTEMBER 3RD

12PM - 4PM



VISITDEKALB.ORG

SELECT CARS NOW ON DISPLAY AT THE NATMUS MUSEUM

1000 BUEHRING PLACE
AUBURN, IN 46706

NATMUS.ORG | (260) 925-9100



**Leslie Peel,
Executive
Director,
ACD Festival**

PHOTOGRAPHY
Jeffrey Crane

Welcome to the Auburn Cord Duesenberg Festival!

We are excited to welcome you to the 67th ACD Festival featuring the Year of the Supercharged Car. We hope that our mission, “to celebrate and promote automotive heritage,” is most-evident when you visit during Labor Day weekend. Each year our goal is to offer an annual celebration that is filled with a mix of time-honored traditions that highlight our community, the automobiles, and our city’s history that we embrace and cherish, as well as to expand with new experiences.

We look forward to again being included as a part of Destination Auburn, a collaboration among community partners including our local auction, Worldwide Auctioneers. Check out the Event Schedule beginning on page 43 to see this year’s “supercharged” offerings.

It takes the collaboration of many to coordinate the festival each year, including the ACD Club, the ACD Festival board of directors, local museums,

Visit DeKalb, local officials and law enforcement, and many more. Thank you to our generous sponsors, partners, advertisers and supporters, without which we could not offer the ACD Festival experience. While you are in town, be sure to patronize these local businesses. To those who volunteer their time and talents to support our organization before, during and after the festival, your help is invaluable and your hard work is so appreciated. Thank you for all you do!

We hope you enjoy reading the stories in this year’s publication. We are proud to offer this magazine annually with the help of many of those previously mentioned, including the talented staff at *Business People*.

Join us as we welcome the ACD Club back to town for its yearly reunion and “supercharged” Labor Day weekend. Safe travels! ■

WE'RE PROUD TO SERVE

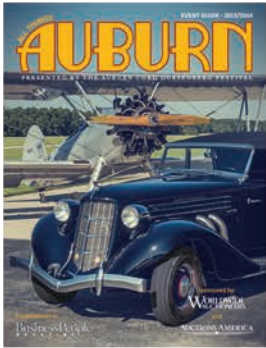

2013



2014

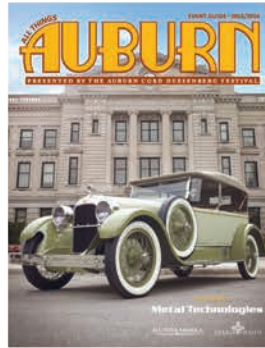

2015



2016

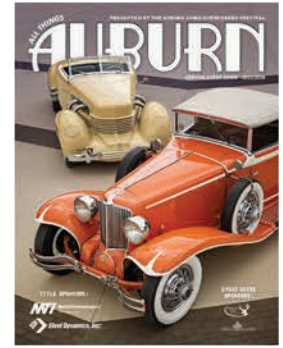

2017



2018

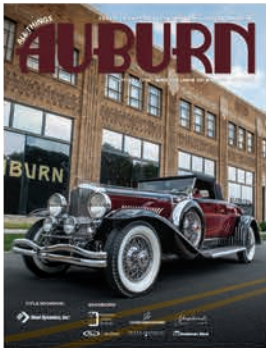

2019



2021

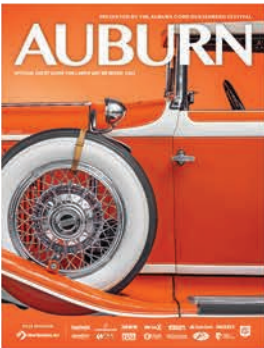

2022

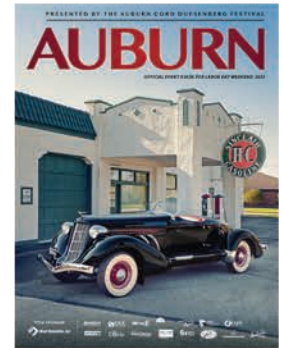

2023

THE ACD FESTIVAL

WE'RE HONORED TO PUBLISH **AUBURN** - FOR 10 YEARS NOW.

MICHIANA BUSINESS PUBLICATIONS INC.

BUSINESS PEOPLE



LIVING

BUSINESS WOMEN OF NORTHEAST INDIANA

AUBURN



TO LEARN HOW WE CAN HELP YOUR BUSINESS GROW, CALL (260) 497-0433 OR VISIT OUR WEBSITE BUSINESSPEOPLE.COM

Speed into amazing.

- ▶ Fast download speeds available from 100 Mbps up to 1 GIG[†]
- ▶ Faster than advertised download speeds (*FCC Twelfth Measuring Broadband America Fixed Broadband Report*)
- ▶ Powerful whole-home WiFi
- ▶ 99.99% network reliability[^]



xtream.com
844-XTREAM3

XTREAM
POWERED BY **Mediacom**.

[†]Download speeds may vary and a monthly usage allowance applies. Services may not be available in all areas.
[^]2023 Mediacom Executive Summary Reliability Report. Xtream powered by Mediacom is a registered trademark of Mediacom Communications Corporation.

A MINORITY-OWNED BUSINESS

"GOING THE EXTRA MILE TO DELIVER
CUSTOMER SATISFACTION,"

"WE GIVE
A SHIP"



FAK.
LOGISTICS, INC



WWW.FAKSHIPPING.COM

CALL US TODAY
+260-449-9034

Locally owned **BROKER OF FREIGHT** of all kinds specializing in **OVER-THE-ROAD TRANSPORTATION.**

The SweetCars logo features the brand name in a white, bold, sans-serif font. The text is underlined by a red, dashed line that curves around the bottom of the letters. The background of the entire advertisement is a photograph of an orange McLaren sports car, viewed from a front-three-quarter perspective, parked on a paved road with lush green trees in the background.

SweetCars

ENJOY THE RIDE

Extraordinary Vehicles & Services from a Dealership You Can Trust

Our passion goes beyond the pedal – SweetCars takes a sincere approach to buying, selling, and maintaining vehicles.

Whether you're looking for your dream car or taking care of your prized ride, our knowledgeable sales, maintenance, and nationally-recognized detailing team provides the services and expertise to exceed your expectations.

Visit [SweetCars.com](https://www.sweetcars.com) to see our inventory and learn about our premium car care products and detailing services.

- ✓ Friendly, personal service
- ✓ Honest, transparent pricing
- ✓ Highest quality products
- ✓ Extraordinary vehicle selection
- ✓ Committed to doing the right thing

Vehicle Sales & Consignment • Service & Maintenance • World-Class Detailing

2404 W Jefferson Blvd • Fort Wayne, IN • (260) 207-2277